

INSTALLATION GUIDELINES

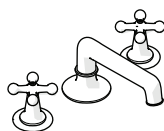

STYLE No. DSLS01

Dash Low Profile Three Hole Deck Mounted Lavatory Faucet with Metal Cross Handles

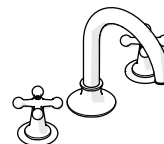

STYLE No. DSLS20

Dash Gooseneck Three Hole Deck Mounted Lavatory Faucet with Metal Cross Handles

IMPORTANT:

- To ensure this product is installed properly, you must read and follow these guidelines.
- The owner/user of this product must keep this information for future reference.
- This product must be installed by a professional licensed contractor.
- Be sure your installation conforms to federal state, and local codes. In the State of Massachusetts, all installations must comply with the rules and regulations set forth within 248 CMR.
- Inspect this product to ensure you have all the parts required for proper installation. Product is sold partially assembled but shown fully disassembled for illustrative and service purposes only.
- Use only a strap wrench or protected/smooth-jaw wrench on any finished surface.
- The use of certain plumber's putty may stain stone or tile surfaces.
- If further assistance is required, please contact Product Support at 1-800-927-2120 Monday through Friday, 8am - 6pm EST.
- Refer to the separate Service Parts Documents for available replacement parts.

TECHNICAL DETAILS:

STYLE	DETAIL	SPECIFICATION
ALL	DECK THICKNESS	1/4" [6mm] MIN 1-9/16" [40mm] MAX
ALL	DRAIN DEPTH	3/8" [10mm] MIN 2-5/8" [67mm] MAX
ALL	DRAIN HOLE DIAMETER	Ø1-3/4" [44mm]
ALL	DRAIN STYLE	PUSH TOUCH
ALL	FITTINGS HOLE DIAMETER	Ø1-3/8" [35mm]
ALL	HANDLE SPREAD	8" [203mm] MIN 12" [305mm] MAX
ALL	HANDLE TURN ANGLE	QUARTER TURN
ALL	INLET CONNECTION	1/2" Male with Supply Nut
DSLS01	SPOUT REACH	5-3/4" [145mm]
DSLS20		6-1/16" [154mm]
ALL	CARTRIDGE VALVE MATERIAL	CERAMIC
ALL	WATER PRESSURE RANGE	20psi [1.5 bar] MIN 85psi [6.0 bar] MAX
ALL	WATER PRESSURE RECOMMENDED	45psi [3.0 bar]

INSTALLATION GUIDELINES

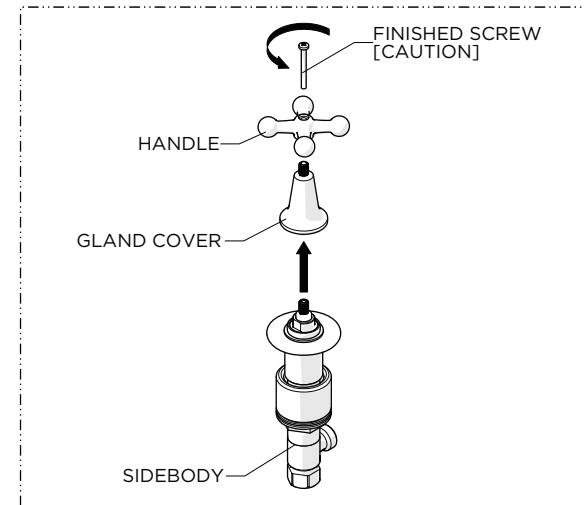
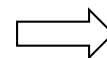
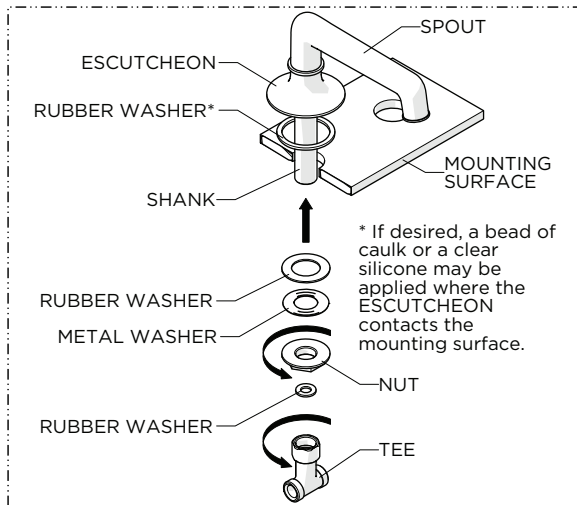
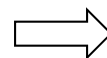
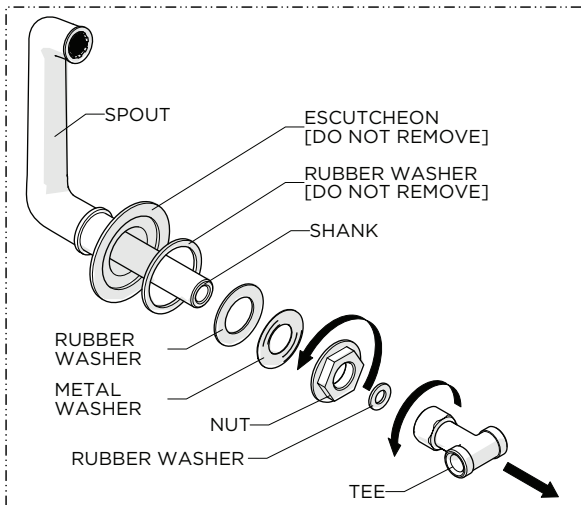
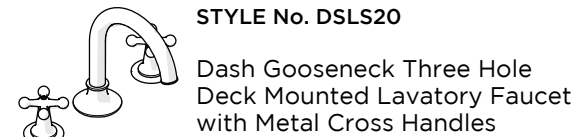
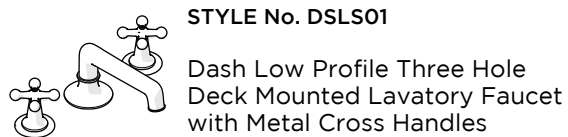

1. Remove the TEE, NUT and lower deck WASHERS from the SPOUT SHANK. Do NOT remove the WASHER from the ESCUTCHEON.

2. Insert the SHANK through the hole on the mounting surface then re-attach the WASHERS, NUT, and TEE and securely tighten the NUT.

3. Carefully unthread the FINISHED SCREW then pull the HANDLE and GLAND COVER up.

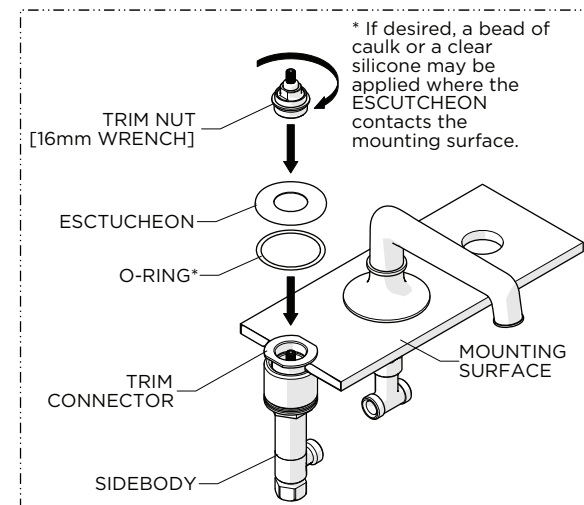
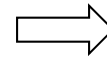
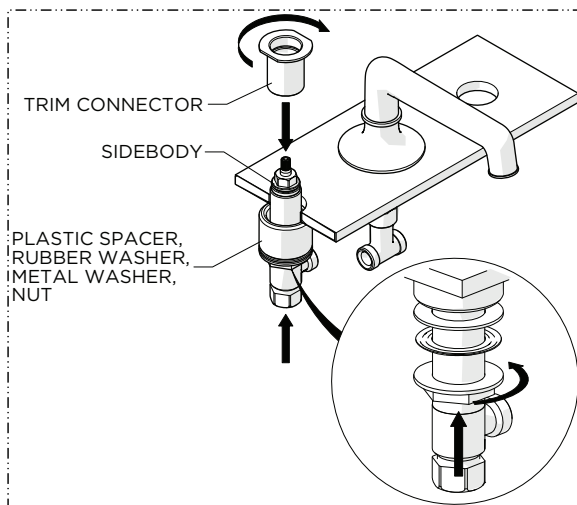
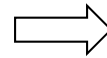
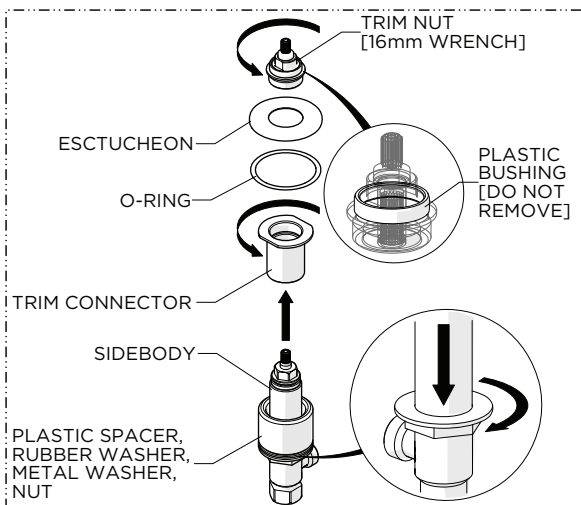

4. Unthread and remove the TRIM NUT, remove the ESCUTCHEON with the O-RING, unthread and remove the TRIM CONNECTOR then fully thread the NUT down the SIDEBODY.

5. Thread the TRIM CONNECTOR back onto the SIDEBODY until it stops and let it rest on the mounting surface then hand-tighten the NUT against the underside of the mounting surface.

6. Place the ESCUTCHEON and O-RING over the TRIM CONNECTOR then thread and securely tighten the TRIM NUT into the TRIM CONNECTOR;

CAUTION: Do NOT remove the PLASTIC BUSHING on the TRIM NUT

CAUTION: Do NOT over tighten the NUT to allow for proper handle alignment during HANDLE installation.

INSTALLATION GUIDELINES

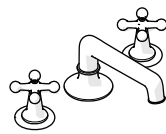

STYLE No. DSLS01

Dash Low Profile Three Hole Deck Mounted Lavatory Faucet with Metal Cross Handles

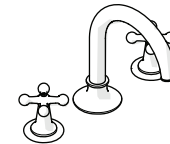

STYLE No. DSLS20

Dash Gooseneck Three Hole Deck Mounted Lavatory Faucet with Metal Cross Handles

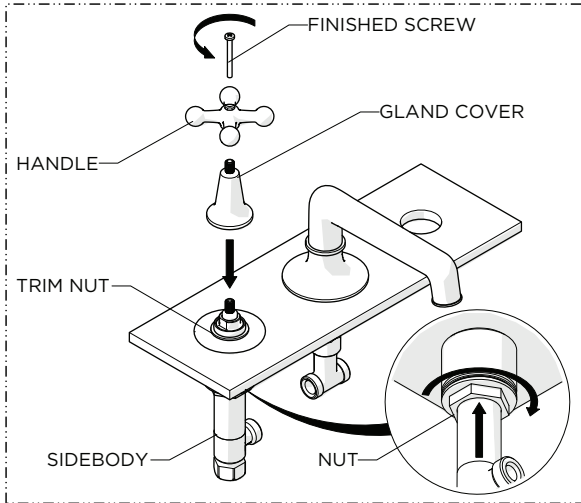

7. Re-attach the GLAND COVER, HANDLE, and FINISHED SCREW. Ensure the HANDLE is in the desired orientation then securely tighten the NUT on the SIDEBODY.

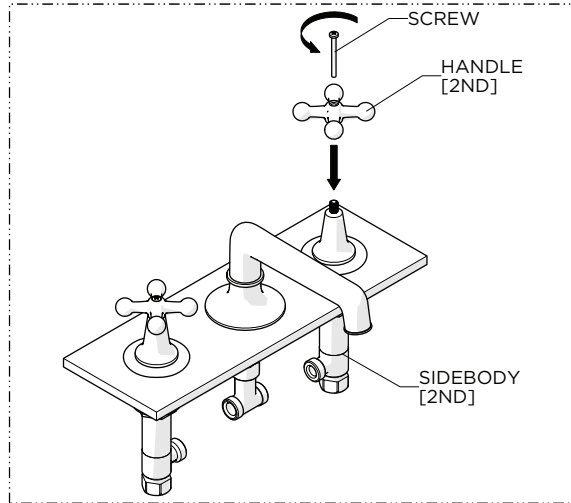

8. Repeat Steps 3 through 7 to install the second HANDLE.

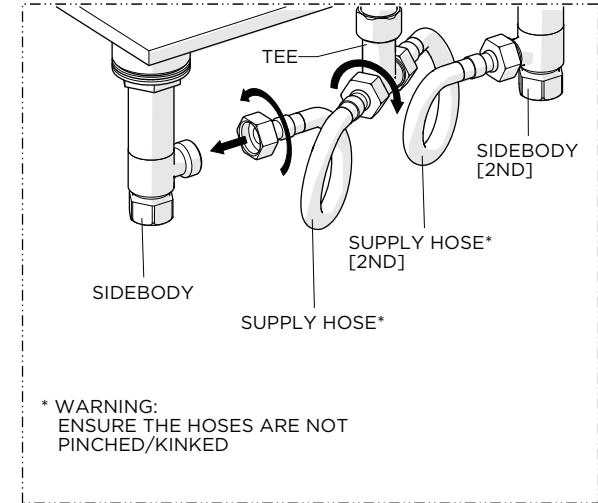

* WARNING: ENSURE THE HOSES ARE NOT PINCHED/KINKED

9. Connect the SIDEBODIES to the TEE using the SUPPLY HOSES provided. Securely tighten the HOSES and ensure they are not pinched/kinked.

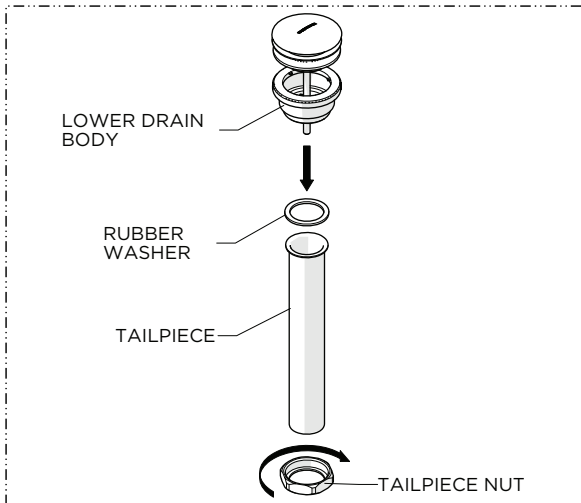

10. Remove the TAILPIECE from the LOWER DRAIN BODY.

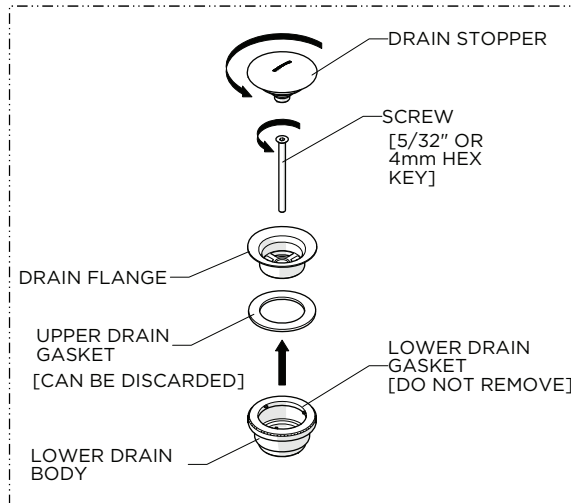

11. Unthread and remove the DRAIN STOPPER and LOWER DRAIN BODY from the DRAIN FLANGE. The UPPER DRAIN GASKET can be discarded.

CAUTION: Do NOT discard the LOWER DRAIN GASKET.

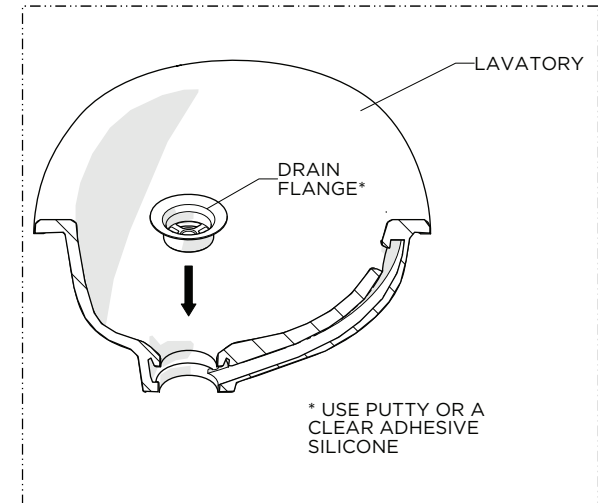

12. Set the DRAIN FLANGE in the lavatory [SOLD SEPARATELY] using putty or a clear adhesive silicone.

* USE PUTTY OR A CLEAR ADHESIVE SILICONE

INSTALLATION GUIDELINES

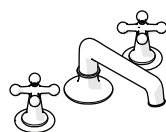

STYLE No. DSLS01

Dash Low Profile Three Hole Deck Mounted Lavatory Faucet with Metal Cross Handles

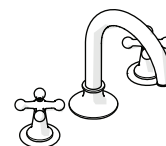

STYLE No. DSLS20

Dash Gooseneck Three Hole Deck Mounted Lavatory Faucet with Metal Cross Handles

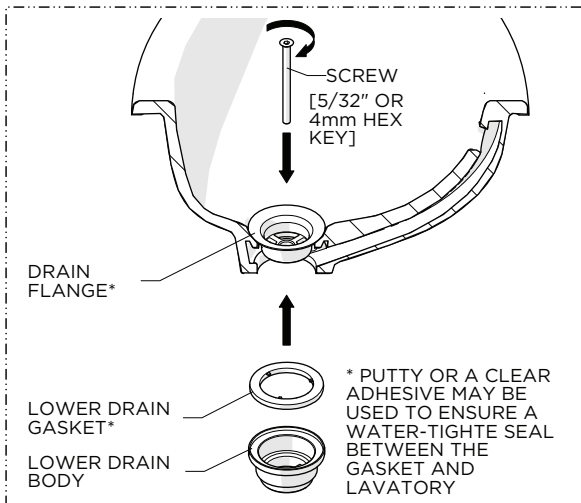

13. Re-install the LOWER DRAIN BODY making sure to use the GASKET provided. Ensure the GASKET makes a full seal on the underside of the lavatory then securely tighten the SCREW.

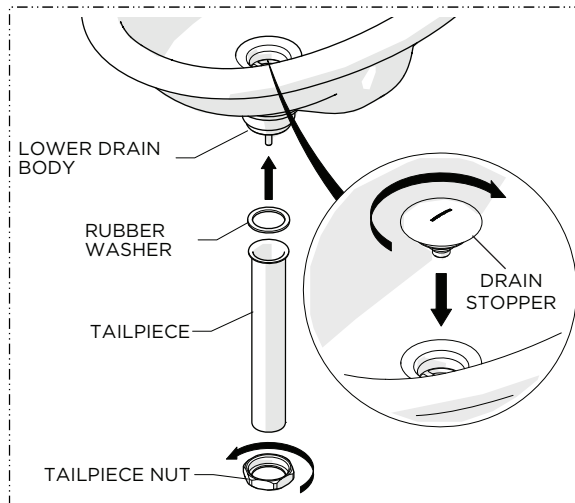

14. Re-install the DRAIN STOPPER then the TAILPIECE using the WASHER and NUT provided.

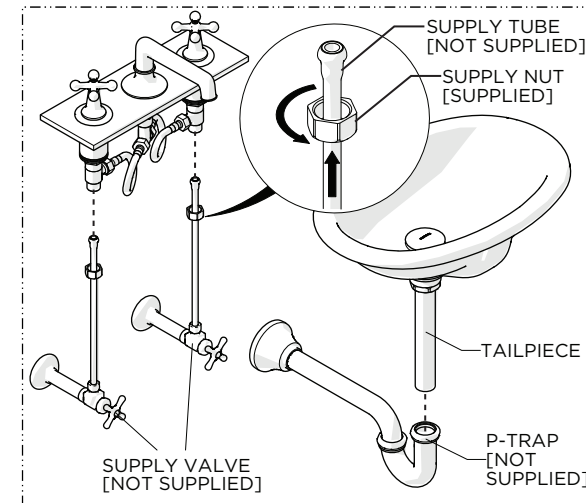

15. Make final P-TRAP [sold separately] and SUPPLY VALVE [sold separately] connections.

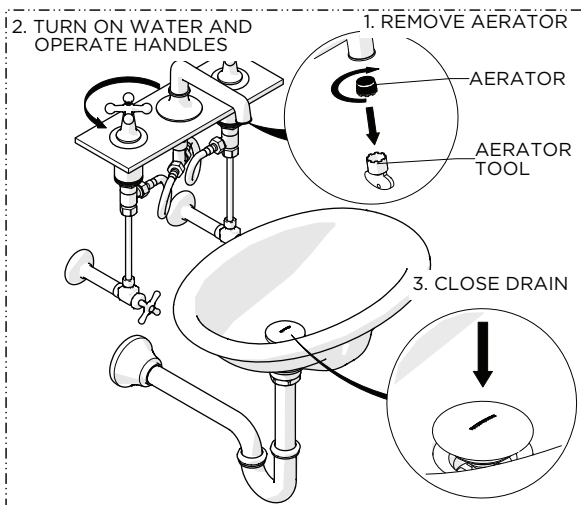

16. Removed the AERATOR, turn on the water to flush out the supply lines, and inspect all connections for leaks. Close the DRAIN to ensure it functions properly then turn off the water and re-install the AERATOR.

NOTE: 2-3 Seconds of residual water is typical on large gooseneck faucets.