

.25

PTS280

.25 8" Rain Showerhead with 6" Ceiling Mounted Shower Arm



SHOWN IN .25 8" RAIN SHOWERHEAD WITH 6" CEILING MOUNTED SHOWER ARM | PTS280

TECHNICAL DETAILS

Adjustable Versus Fixed Spray: Fixed
Fittings Hole Diameter: 1 1/4"
Flow Restriction Options: 1.5, 1.75, 2.0
Inlet Connection Size: 1/2"
Inlet Connection Type: Male NPT
Pivot: Y
Primary Material: Brass
Restricted Maximum Flow Rate: 1.75 gpm
Water Pressure Maximum: 85.0 psi
Water Pressure Minimum: 20.0 psi
Water Pressure Recommended: 45.0 psi

INSPIRATION

.25 is the ultimate in utilitarian elegance: A simple and understated design that is equally functional and beautiful.

CODES & STANDARDS

PTS280X, ASME A112.18.1/CSA B125.1, CEC(1.5GPM & 1.75GPM Only), WaterSense(1.5GPM, 1.75GPM & 2.0GPM Only), DOE, State of MA

PRODUCT FEATURES

Made of Brass

Features a swivel 8" rain showerhead with easy clean rubber nozzles

Includes a 6" ceiling mounted shower arm

Stocked in Brass, Chrome, Nickel and Matte Nickel

Rain showerhead available in 1.75gpm (6.6L/min) flow rate

CERTIFICATIONS



PRODUCT (NOTES)

.25

PTS280

.25 8" Rain Showerhead with 6" Ceiling Mounted Shower Arm

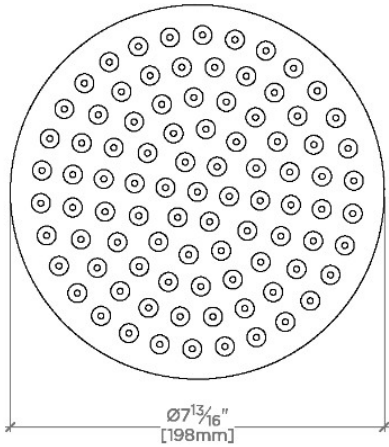

CEILING VIEW

SCALE: 3"=1'-0"

STYLE NO.	DIM "A"	DIM "B"
LVS280	10 ⁵ / ₁₆ " [261mm]	6 ⁹ / ₁₆ " [167mm]
PTS280		
LVS281	16 ⁵ / ₁₆ " [414mm]	12 ⁹ / ₁₆ " [319mm]
PTS281		

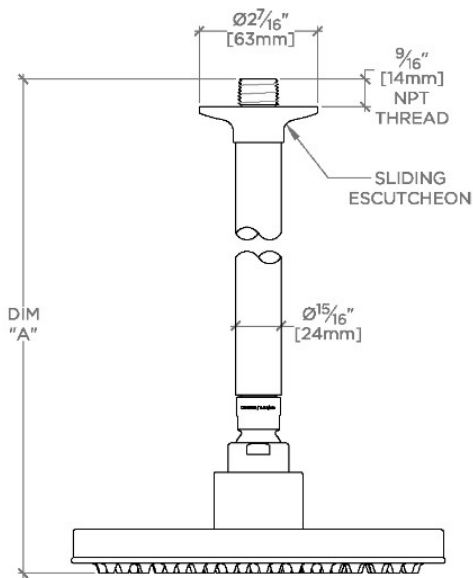

FRONT VIEW

SCALE: 3"=1'-0"

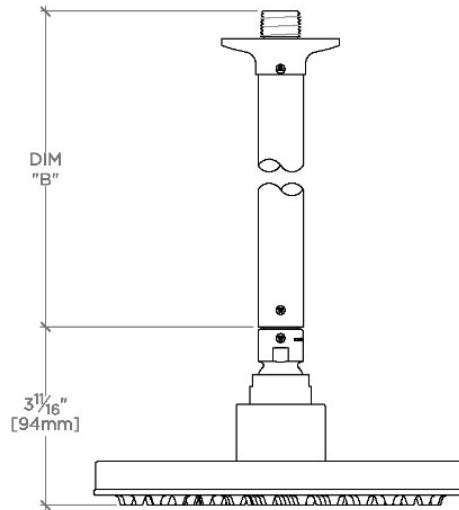

SIDE VIEW

SCALE: 3"=1'-0"