

JULIA

JUS109

Julia 10" Rain Showerhead with 22" Wall Mounted 90 Degree Shower Arm



SHOWN IN JULIA 10" RAIN SHOWERHEAD WITH 22" WALL MOUNTED 90 DEGREE SHOWER ARM | JUS109

TECHNICAL DETAILS

Adjustable Versus Fixed Spray: Fixed
 Fittings Hole Diameter: 1 1/4"
 Flow Restriction Options: 1.5, 1.75, 2.0
 Inlet Connection Size: 1/2"
 Inlet Connection Type: Male NPT
 Pivot: Y
 Primary Material: Brass
 Restricted Maximum Flow Rate: 1.75 gpm
 Water Pressure Maximum: 85.0 psi
 Water Pressure Minimum: 20.0 psi
 Water Pressure Recommended: 45.0 psi

INSPIRATION

An interpretation of 1920s French country, Julia speaks to decoration and intricate design displayed through beautifully composed turnings. These details embody the robust, signature high profile spout enabling Julia to transition fluidly from informal to formal environments.

CODES & STANDARDS

JUS109X, ASME A112.18.1/CSA B125.1, CEC(1.5GPM & 1.75GPM Only), WaterSense(1.5GPM, 1.75GPM & 2.0GPM Only), DOE, State of MA

PRODUCT FEATURES

- Made of Brass
- Features a swivel 10" rain showerhead with easy clean rubber nozzles
- Includes a 22" wall mounted 90 degree shower arm
- Stocked in Brass, Chrome, Nickel and Matte Nickel
- Rain showerhead available in 1.75gpm (6.6L/min) flow rate

CERTIFICATIONS



PRODUCT (NOTES)

WATERWORKS

JULIA

JUS109

Julia 10" Rain Showerhead with 22" Wall Mounted 90 Degree Shower Arm

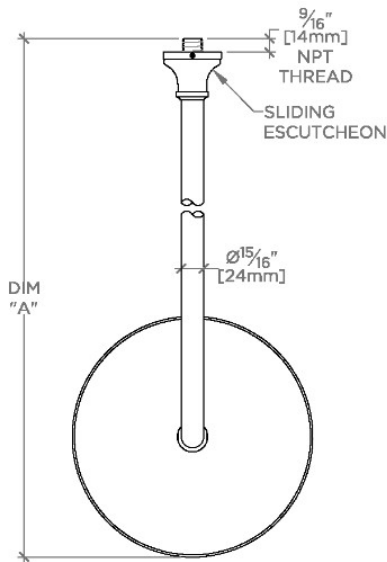

TOP VIEW SCALE: 1/2"=1'-0"

STYLE NO.	DIM "A"	DIM "B"
ETS108		
FRS108	23 ⁹ / ₁₆ " [599mm]	18 ⁹ / ₁₆ " [472mm]
JUS108		
ETS109		
FRS109	27 ⁹ / ₁₆ " [699mm]	22 ⁹ / ₁₆ " [573mm]
JUS109		

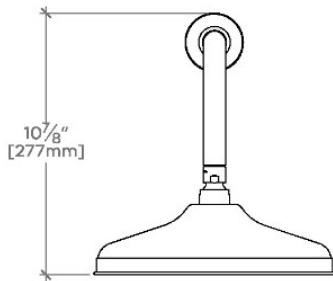

FRONT VIEW SCALE: 1/2"=1'-0"

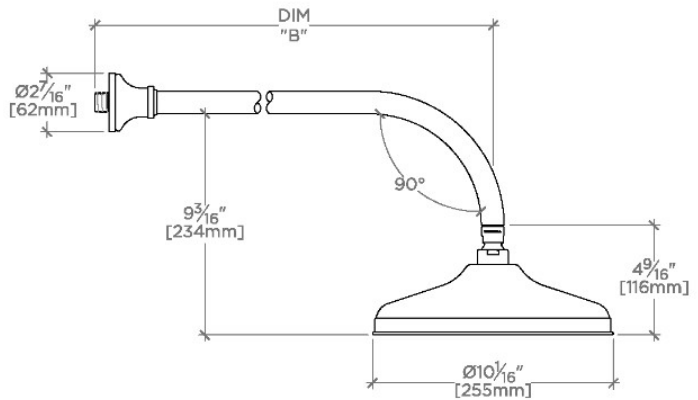

SIDE VIEW SCALE: 1/2"=1'-0"