

Universal

UCCL24

Universal Classic 24" Ceiling Mounted Shower Arm with Low Profile Flange



SHOWN IN UNIVERSAL CLASSIC 24" CEILING MOUNTED SHOWER ARM WITH LOW PROFILE FLANGE | UCCL24

TECHNICAL DETAILS

Fittings Hole Diameter: 32 mm
Inlet Connection Size: 1/2"
Inlet Connection Type: Male NPT
Outlet Connection Size: 1/2"
Outlet Connection Type: Male NPT
Water Pressure Recommended: 3.0 bar

INSPIRATION

Featuring enduring designs that complement any Waterworks element, this collection spans fittings to accessories, bringing exquisite proportion and balance to any environment.

CODES & STANDARDS

PRODUCT FEATURES

Compatible with an assortment of Waterworks showerheads, sold separately

Brass Construction

Includes 24" ceiling mounted shower arm

Stocked in Chrome, Nickel and Brass

CERTIFICATIONS

PRODUCT (NOTES)

Universal

UCCL24

Universal Classic 24" Ceiling Mounted Shower Arm with Low Profile Flange

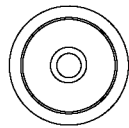

TOP VIEW SCALE: 3"=1'-0"

STYLE NO.	DIM "A"	DIM "B"
UCCL06	7 ¹ / ₈ " [181mm]	6 ⁹ / ₁₆ " [167mm]
UCCL12	13 ¹ / ₈ " [334mm]	12 ⁹ / ₁₆ " [319mm]
UCCL18	19 ¹ / ₈ " [486mm]	18 ⁹ / ₁₆ " [471mm]
UCCL24	25 ¹ / ₈ " [639mm]	24 ⁹ / ₁₆ " [624mm]

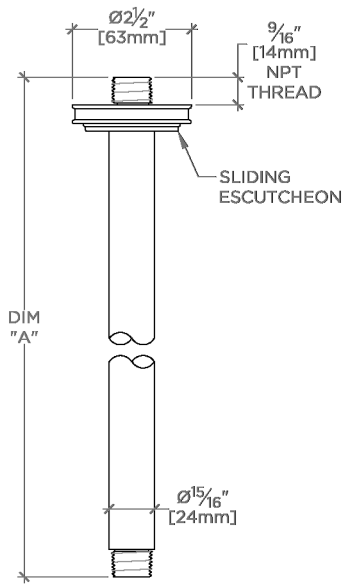

FRONT VIEW SCALE: 3"=1'-0"

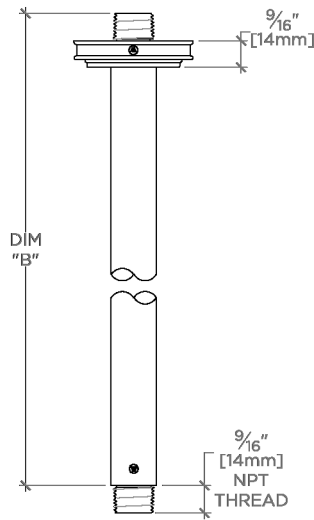

SIDE VIEW SCALE: 3"=1'-0"