

## Universal

UCWH08

Universal Classic 8" Wall Mounted 45 Degree Shower Arm with High Profile Flange

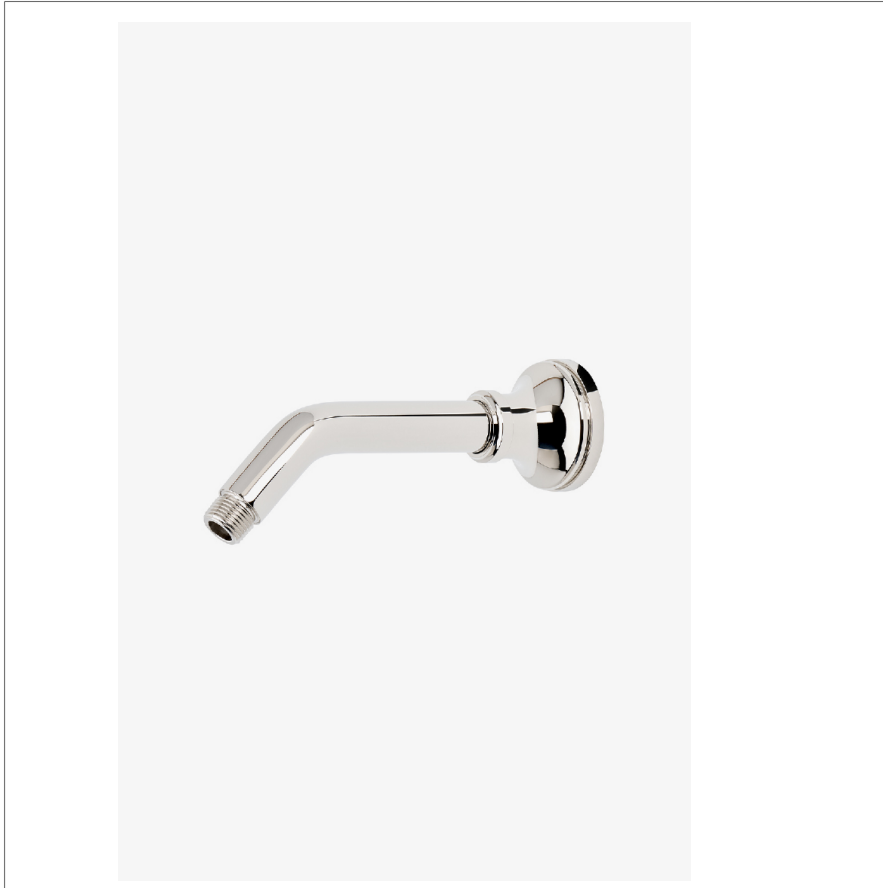

SHOWN IN UNIVERSAL CLASSIC 8" WALL MOUNTED 45 DEGREE SHOWER ARM WITH HIGH PROFILE FLANGE | UCWH08

### TECHNICAL DETAILS

Fittings Hole Diameter: 32 mm  
Inlet Connection Size: 1/2"  
Inlet Connection Type: Male NPT  
Outlet Connection Size: 1/2"  
Outlet Connection Type: Male NPT  
Water Pressure Recommended: 3.0 bar

### INSPIRATION

Featuring enduring designs that complement any Waterworks element, this collection spans fittings to accessories, bringing exquisite proportion and balance to any environment.

### CODES & STANDARDS

### PRODUCT FEATURES

Compatible with an assortment of Waterworks showerheads, sold separately

Brass Construction

Includes 8" wall mounted 45 degree shower arm

Stocked in Chrome, Nickel and Brass

### CERTIFICATIONS

### PRODUCT (NOTES)

## Universal

## UCWH08

Universal Classic 8" Wall Mounted 45 Degree Shower Arm  
with High Profile Flange

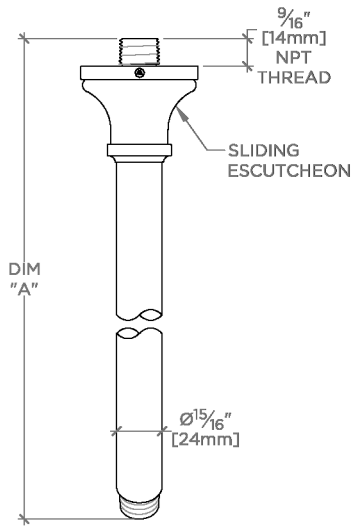

TOP VIEW SCALE: 3"=1'-0"

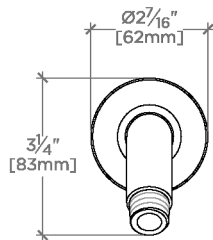

FRONT VIEW SCALE: 3"=1'-0"

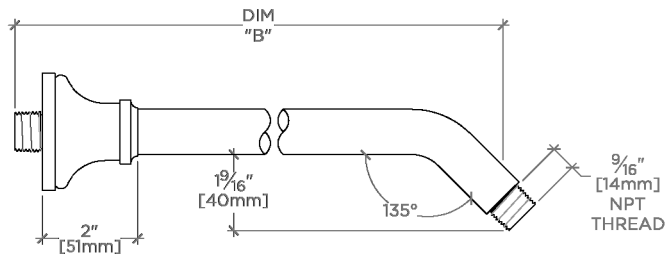

SIDE VIEW SCALE: 3"=1'-0"

STYLE NO.	DIM "A"	DIM "B"
UCWH06	6 <sup>15</sup> / <sub>16</sub> " [176mm]	6 <sup>1</sup> / <sub>4</sub> " [158mm]
UCWH08	8 <sup>15</sup> / <sub>16</sub> " [226mm]	8 <sup>1</sup> / <sub>4</sub> " [209mm]
UCWH10	10 <sup>15</sup> / <sub>16</sub> " [277mm]	10 <sup>1</sup> / <sub>4</sub> " [260mm]