

Etoile

ETS180

Etoile 8" Rain Showerhead with 6" Ceiling Mounted Shower Arm



SHOWN IN ETOILE 8" RAIN SHOWERHEAD WITH 6" CEILING MOUNTED SHOWER ARM | ETS180

TECHNICAL DETAILS

Adjustable Versus Fixed Spray: Fixed
 Fittings Hole Diameter: 32 mm
 Flow Restriction Options: 1.5, 1.75, 2.0
 Inlet Connection Size: 1/2"
 Inlet Connection Type: Male NPT
 Pivot: Y
 Primary Material: Brass
 Restricted Maximum Flow Rate: 6.6 liters/min
 Water Pressure Maximum: 6.0 bar
 Water Pressure Minimum: 1.5 bar
 Water Pressure Recommended: 3.0 bar

INSPIRATION

Defined elegance. Etoile has a European sophistication with a timeless sense of chic.

CODES & STANDARDS

ETS180X, ASME A112.18.1/CSA B125.1, CEC(1.5GPM & 1.75GPM Only), WaterSense(1.5GPM, 1.75GPM & 2.0GPM Only), DOE, State of MA

PRODUCT FEATURES

Made of Brass

Features a swivel 8" rain showerhead with easy clean rubber nozzles

Includes a 6" ceiling mounted shower arm

Stocked in Brass, Chrome, Nickel and Matte Nickel

Rain showerhead available in 1.75gpm (6.6L/min) flow rate

CERTIFICATIONS



PRODUCT (NOTES)

Etoile

ETS180

Etoile 8" Rain Showerhead with 6" Ceiling Mounted Shower Arm

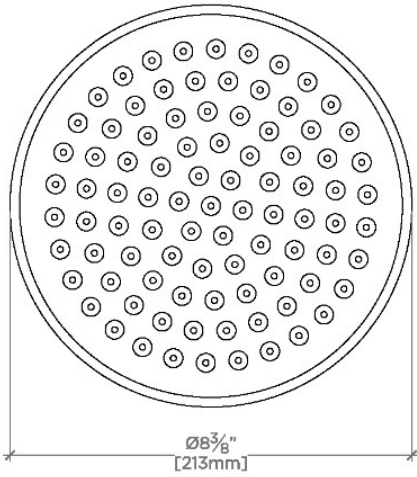

CEILING VIEW

SCALE: 3"=1'-0"

STYLE NO.	DIM "A"	DIM "B"
ETS180	1 1/8" [283mm]	6 9/16" [167mm]
FRS180		
JUS180		
ETS181	1 7/8" [435mm]	12 9/16" [319mm]
FRS181		
JUS181		

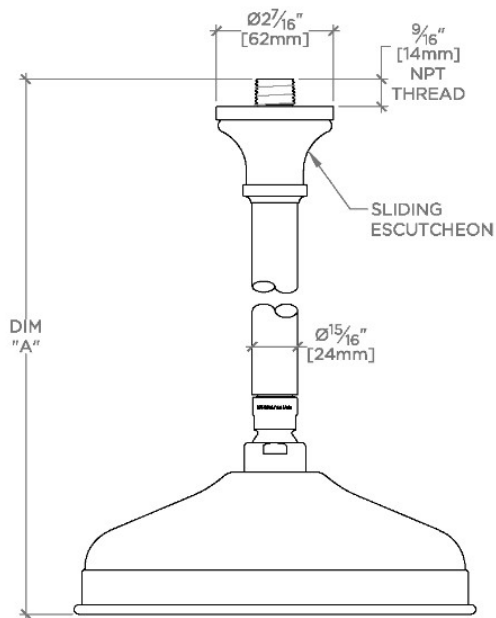

FRONT VIEW

SCALE: 3"=1'-0"

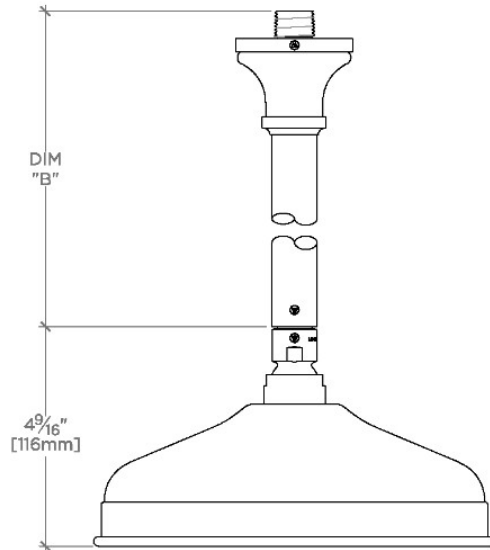

SIDE VIEW

SCALE: 3"=1'-0"