

Henry Chronos

CNS345

Henry Chronos 3 1/2" Showerhead with Adjustable Spray with 8" Wall Mounted 45 Degree Shower Arm

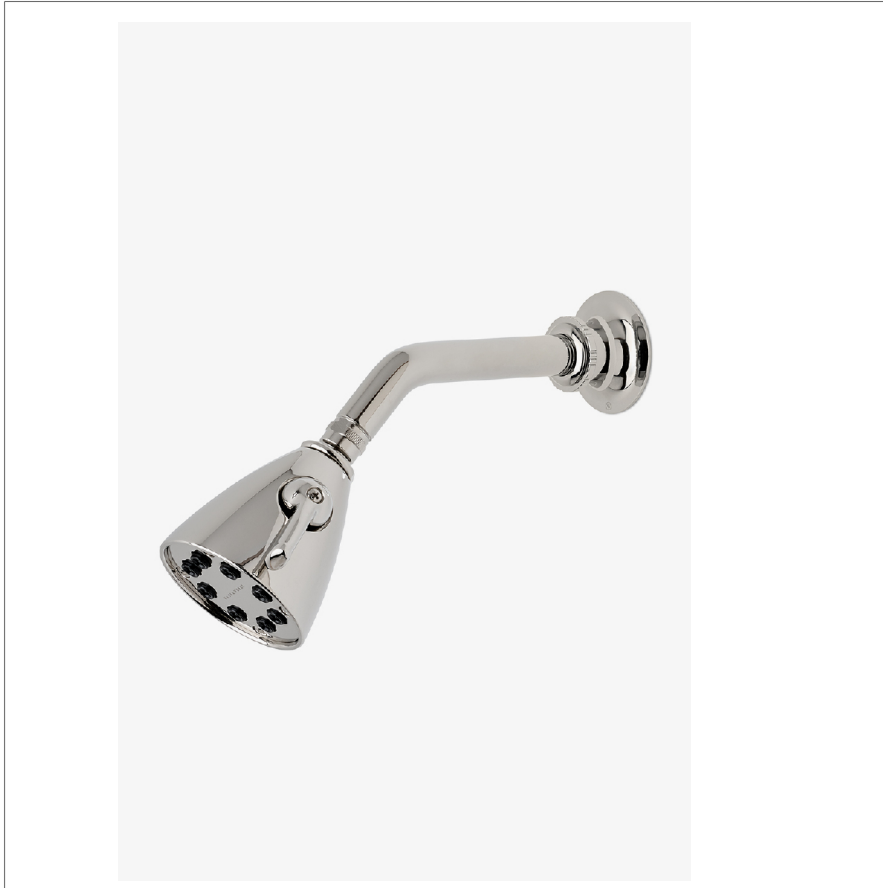

SHOWN IN HENRY CHRONOS 3 1/2" SHOWERHEAD WITH ADJUSTABLE SPRAY WITH 8" WALL MOUNTED 45 DEGREE SHOWER ARM | CNS345

TECHNICAL DETAILS

Fittings Hole Diameter: 35 mm
 Flow Restriction Options: 1.5, 1.75, 2.0
 Inlet Connection Size: 1/2"
 Inlet Connection Type: Male NPT
 Pivot: Y
 Restricted Maximum Flow Rate: 6.6 liters/min
 Water Pressure Maximum: 6.0 bar
 Water Pressure Minimum: 1.5 bar
 Water Pressure Recommended: 3.0 bar

INSPIRATION

Inspired by dive watches, Henry Chronos radiates design prowess and technical precision. Chronos retains the design integrity of our original, iconic Henry collection, while imbuing it with modern details and exquisite materials.

CODES & STANDARDS

CNS345X, ASME A112.18.1/CSA B125.1, CEC(1.5GPM & 1.75GPM Only), WaterSense(1.5GPM, 1.75GPM & 2.0GPM Only), DOE, State of MA

PRODUCT FEATURES

- Made of Brass
- Features a swivel 3 1/2" showerhead with two adjustable spray patterns
- Includes a 6" wall mounted 45 degree shower arm
- Stocked in Brass, Chrome and Nickel
- Showerhead available in 1.75gpm (6.6L/min) flow rate

CERTIFICATIONS



PRODUCT (NOTES)

Henry Chronos

CNS345

Henry Chronos 3 1/2" Showerhead with Adjustable Spray
with 8" Wall Mounted 45 Degree Shower Arm

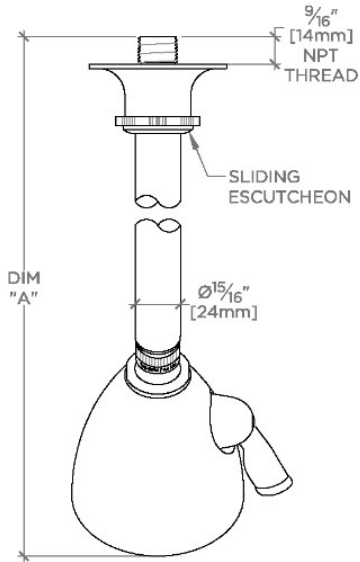

TOP VIEW

SCALE: 3"=1'-0"

STYLE NO.	DIM "A"	DIM "B"
CNS344	10 3/4" [274mm]	6 1/4" [158mm]
CNS345	12 3/4" [324mm]	8 1/4" [209mm]

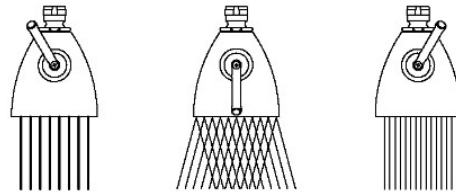

SPRAY PATTERNS

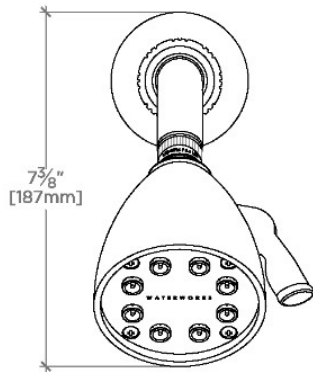

FRONT VIEW

SCALE: 3"=1'-0"

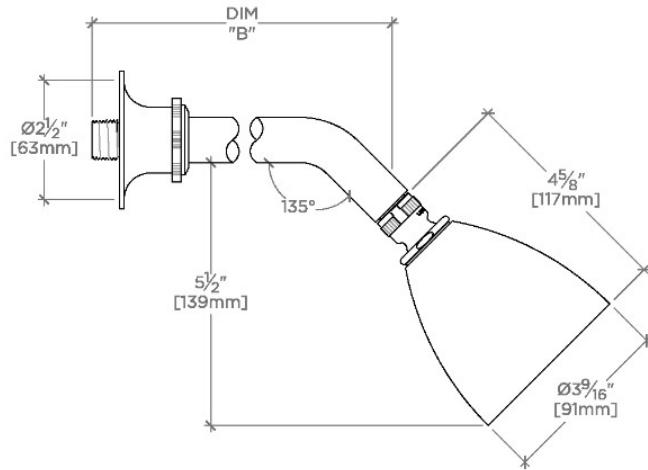

SIDE VIEW

SCALE: 3"=1'-0"