

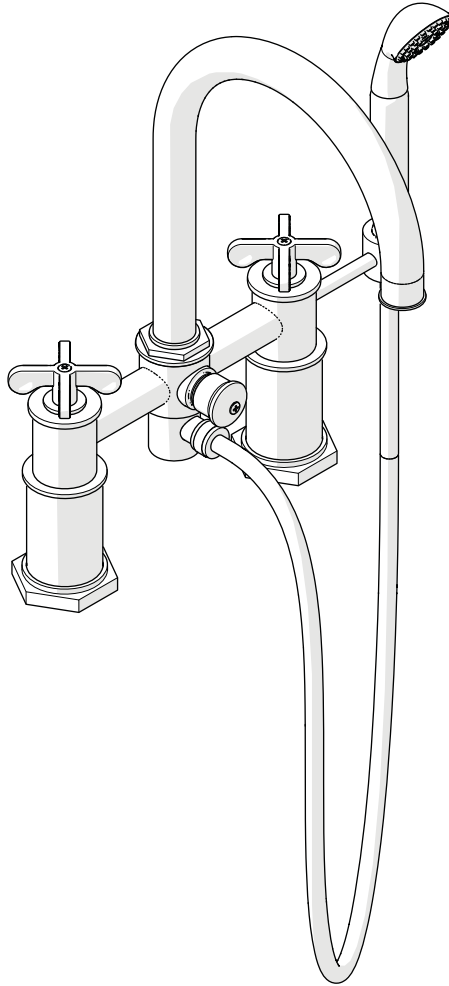

ESTB. 1978

# WATERWORKS

## SERVICE PARTS



**STYLE HNXT40**

Henry Exposed Deck Mounted Tub Filler With Metal Cross Handles and Handshower

---

WELCOME TO

# WATERWORKS

For over three decades, Waterworks has transformed the bath through an absolute commitment to design authenticity, innovation and quality. A blend of scholarly appreciation and applied experience guarantees mechanical integrity, meticulous craftsmanship, and timeless designs.

---

**TO ORDER PARTS CALL  
1 (800) 927-2120 (EXT 2)**

Order by part number and specify color, finish, or other options if required.

**PRODUCT SUPPORT**

Our Product Support team provides troubleshooting and technical problem resolution, including replacement parts and installation recommendations throughout the life of your product.

Product Support is available Monday through Friday, 8AM-6PM EST.

**LIMITED LIFETIME  
WARRANTY**

Our warranty covers repair and replacement of Waterworks products if within the applicable coverage period and deemed defective by Waterworks. Waterworks will, at its option, repair or replace such products; this does not include installation costs, labor charges, or other incidental or consequential costs.

To obtain your complete warranty or inquire about warranty service, please visit us at [www.waterworks.com](http://www.waterworks.com) or contact our Product Support Team.



ESTB. 1978

WATERWORKS

**MAIN KITS**

**STYLES: HNXT40**

\*FINISH/COLOR MUST BE SPECIFIED WHEN ORDERING  
++SUPPLIED AS A PAIR

**103670\***  
SPOUT

**103669\***  
CROSS HANDLE

**103669\***  
CROSS HANDLE

**337847**  
COUNTERCLOCKWISE ON CARTRIDGE

**337847**  
COUNTERCLOCKWISE ON CARTRIDGE

**103471**  
MOUNTING HARDWARE

**028711**  
3/4" ADAPTER

**103679\***  
HANDSHOWER ELBOW

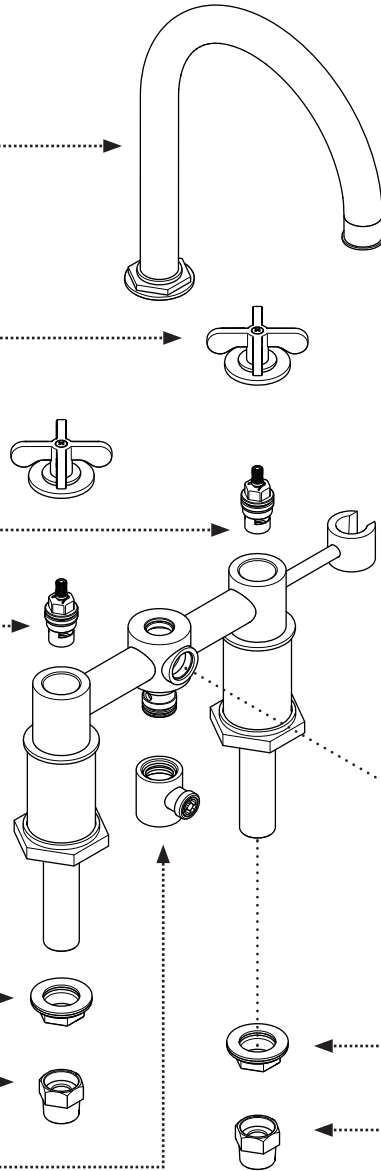

**103675\***  
SPRAY

**103548\***  
HANDSHOWER HOSE

**103674\***  
DIVERTER

**103673\***  
DIVERTER HANDLE

**103471**  
MOUNTING HARDWARE

**028711**  
3/4" ADAPTER

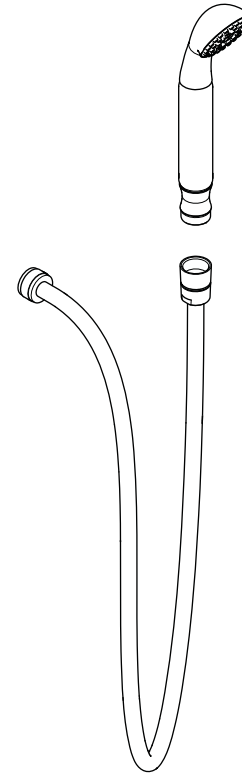



ESTB. 1978

WATERWORKS

### KIT COMPONENTS

STYLES: HNXT40

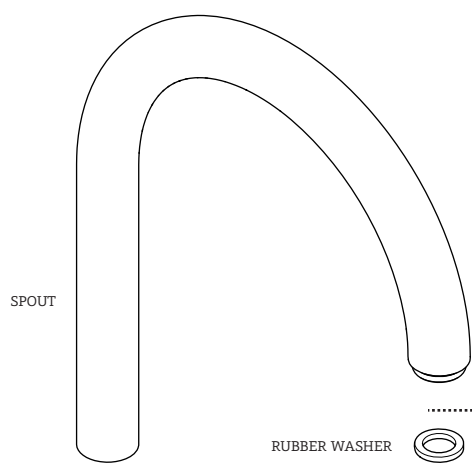

SPOUT

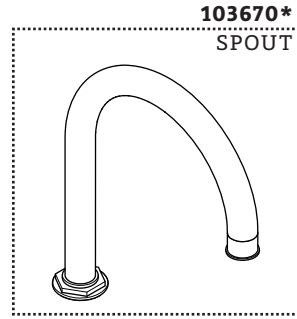

103670\*  
SPOUT



RUBBER WASHER



AERATOR



AERATOR HOUSING



RING

103672\*  
AERATOR



KNURLED COLLAR



O-RING



HEX COLLAR



COLLAR



O-RING



O-RING

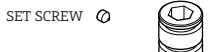

SET SCREW



POST



O-RING

103671  
SPOUT SLIP CONNECTION

\*FINISH/COLOR MUST BE SPECIFIED WHEN ORDERING  
++SUPPLIED AS A PAIR

### KIT COMPONENTS



103679\*  
HANDSHOWER ELBOW

O-RING

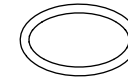

O-RING

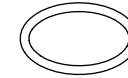

O-RING

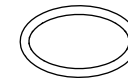

O-RING

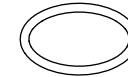

COLLAR

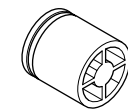
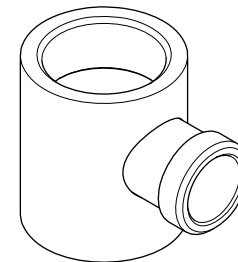

103678  
CHECK VALVE

SCREW





ESTB. 1978

WATERWORKS

**KIT COMPONENTS**

**STYLES: HNXT40**

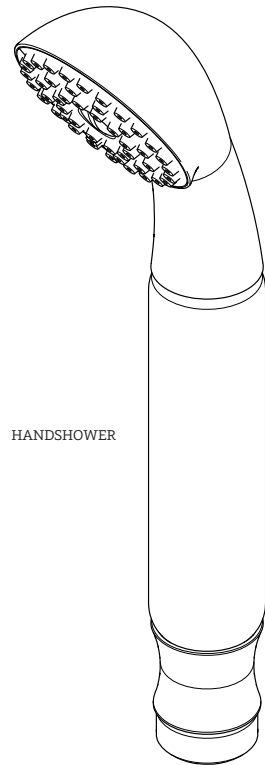

HANDSHOWER

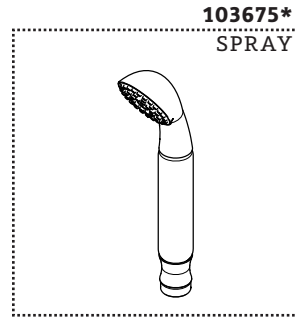

103675\*  
SPRAY

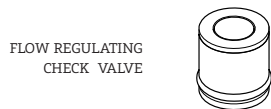

FLOW REGULATING  
CHECK VALVE



CLIP

\*FINISH/COLOR MUST BE SPECIFIED WHEN ORDERING  
++SUPPLIED AS A PAIR

**KIT COMPONENTS**

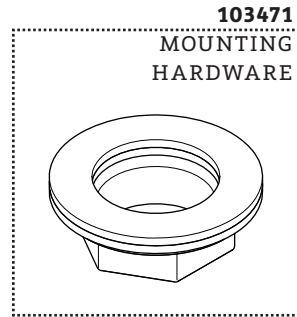

103471  
MOUNTING  
HARDWARE

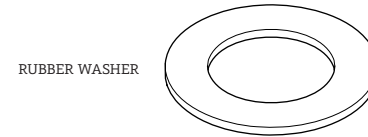

RUBBER WASHER



PLASTIC WASHER

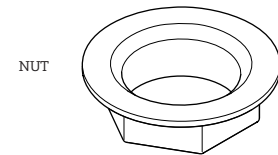

NUT



ESTB. 1978

WATERWORKS

**KIT COMPONENTS**

**STYLES: HNXT40**

**028711**

**3/4" ADAPTER**

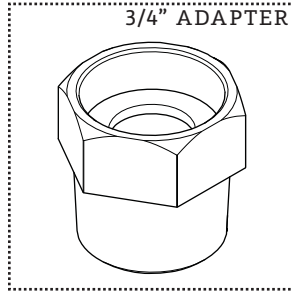

RUBBER WASHER

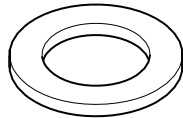

ADAPTER

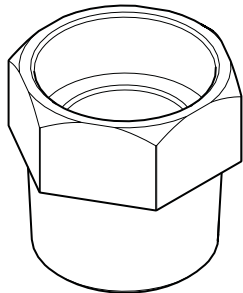

\*FINISH/COLOR MUST BE SPECIFIED WHEN ORDERING  
++SUPPLIED AS A PAIR

**SERVICE PARTS INDEX**

<u>STYLE</u>	<u>DESCRIPTION</u>	<u>PG</u>
028711	3/4" ADAPTER	8
103672*	AERATOR	4
103678	CHECK VALVE	5
337847	COUNTERCLOCKWISE ON CARTRIDGE	2
103669*	CROSS HANDLE	2
103674*	DIVERTER	3
103673*	DIVERTER HANDLE	3
103679*	HANDSHOWER ELBOW	5
103548*	HANDSHOWER HOSE	3
103471	MOUNTING HARDWARE	7
103670*	SPOUT	4
103671	SPOUT SLIP CONNECTION	4
103675*	SPRAY	6

DOCUMENT: SPHN16\_REV01



ESTB. 1978

WATERWORKS

**PRODUCT SUPPORT**

60 BACKUS AVENUE  
DANBURY, CT 06810

1 (800) 927-2120 (EXT 2)

[WWW.WATERWORKS.COM](http://WWW.WATERWORKS.COM)