

Formwork

FMS28C

Formwork 8" Rain Showerhead with 6" Ceiling Mounted Shower Arm



SHOWN IN FORMWORK 8" RAIN SHOWERHEAD WITH 6" CEILING MOUNTED SHOWER ARM | FMS28C

TECHNICAL DETAILS

Adjustable Versus Fixed Spray: Fixed
Fittings Hole Diameter: 32 mm
Flow Restriction Options: 1.5, 1.75, 2.0
Inlet Connection Size: 1/2"
Inlet Connection Type: Male NPT
Pivot: Y
Primary Material: Brass
Restricted Maximum Flow Rate: 6.6 liters/min
Water Pressure Maximum: 6.0 bar
Water Pressure Minimum: 1.5 bar
Water Pressure Recommended: 3.0 bar

INSPIRATION

Sculptural forms that defy the ordinary. Unexpected geometry and the transition of the planes create a subtle but warm expression.

CODES & STANDARDS

FMS28CX, ASME A112.18.1/CSA B125.1, CEC(1.5GPM & 1.75GPM Only), WaterSense(1.5GPM, 1.75GPM & 2.0GPM Only), DOE, State of MA

PRODUCT FEATURES

Made of Brass

Features a swivel 8" rain showerhead with easy clean rubber nozzles

Includes a 6" ceiling mounted shower arm

Stocked in Brass, Chrome and Nickel

Rain showerhead available in 1.75gpm (6.6L/min) flow rate

CERTIFICATIONS



PRODUCT (NOTES)

Formwork

FMS28C

Formwork 8" Rain Showerhead with 6" Ceiling Mounted Shower Arm

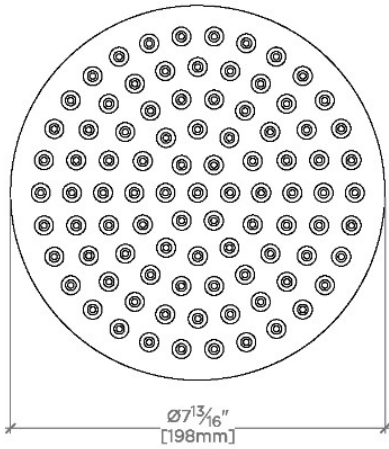

TOP VIEW

SCALE: 3"=1'-0"

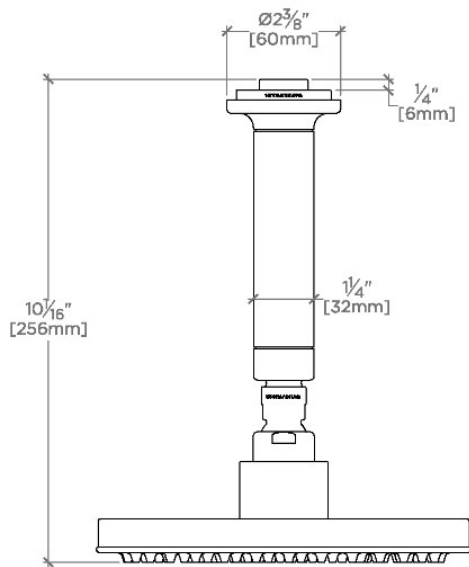

FRONT VIEW

SCALE: 3"=1'-0"

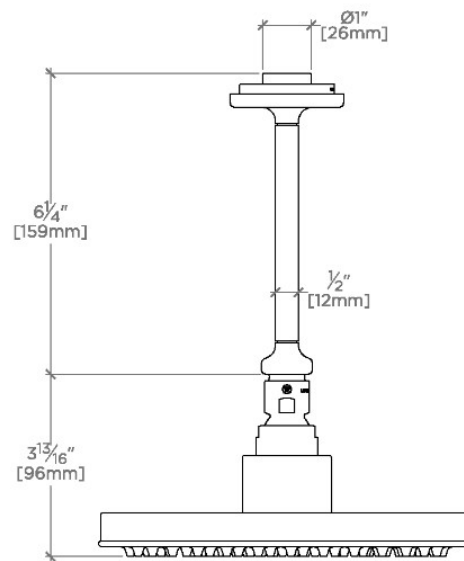

SIDE VIEW

SCALE: 3"=1'-0"