

R.W. Atlas

RWS480

R.W. Atlas 8 1/2" Rain Showerhead with 6" Ceiling Mounted Shower Arm



SHOWN IN R.W. ATLAS 8 1/2" RAIN SHOWERHEAD WITH 6" CEILING MOUNTED SHOWER ARM | RWS480

TECHNICAL DETAILS

Adjustable Versus Fixed Spray: Fixed
Fittings Hole Diameter: 32 mm
Flow Restriction Options: 1.5, 1.75, 2.0
Inlet Connection Size: 1/2"
Inlet Connection Type: Male NPT
Pivot: Y
Primary Material: Brass
Restricted Maximum Flow Rate: 6.6 liters/min
Water Pressure Maximum: 6.0 bar
Water Pressure Minimum: 1.5 bar
Water Pressure Recommended: 3.0 bar

INSPIRATION

Powerful shapes, genuine materials and unique aesthetic details. The original, impeccable vision of R.W. Atlas pairs American ingenuity with European craftsmanship.

CODES & STANDARDS

RWS480X, ASME A112.18.1/CSA B125.1, CEC(1.5GPM & 1.75GPM Only), WaterSense(1.5GPM, 1.75GPM & 2.0GPM Only), DOE, State of MA

PRODUCT FEATURES

Made of Brass

Features a swivel 8 1/2" rain showerhead with easy clean rubber nozzles

Includes a 6" ceiling mounted shower arm

Stocked in Brass and Nickel

Rain showerhead available in 1.75gpm (6.6L/min) flow rate

CERTIFICATIONS



PRODUCT (NOTES)

WATERWORKS

R.W. Atlas

RWS480

R.W. Atlas 8 1/2" Rain Showerhead with 6" Ceiling Mounted Shower Arm

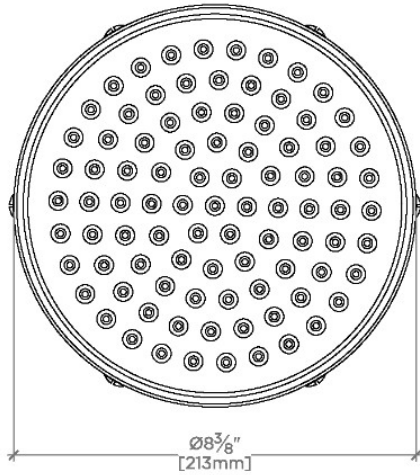

CEILING VIEW

SCALE: 3"=1'-0"

STYLE NO.	DIM "A"	DIM "B"
RWS480	10 ³ / ₈ " [264mm]	6 ⁹ / ₁₆ " [167mm]
RWS481	16 ³ / ₈ " [416mm]	12 ⁹ / ₁₆ " [319mm]

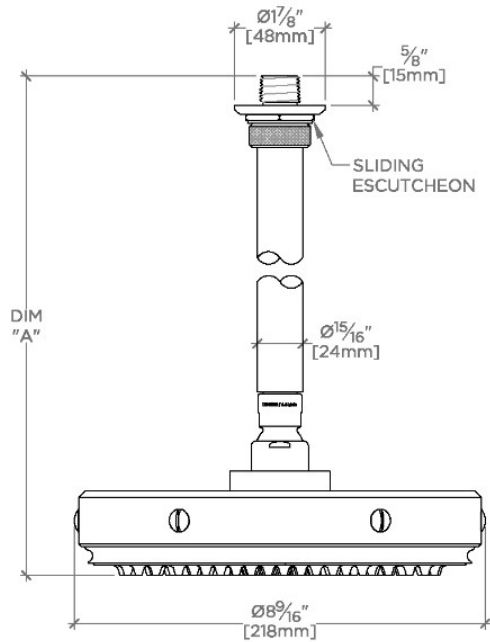

FRONT VIEW

SCALE: 3"=1'-0"

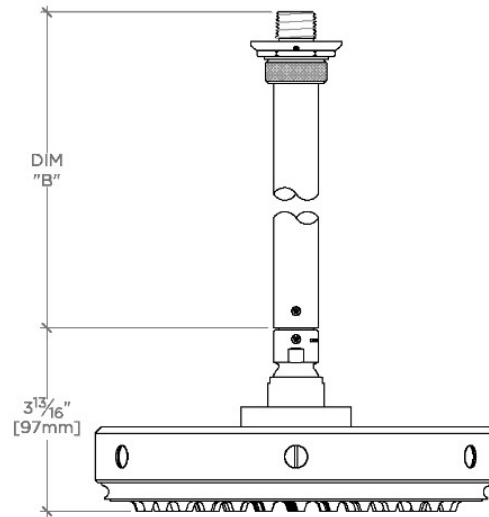

SIDE VIEW

SCALE: 3"=1'-0"