

NORMANDY

NOLV33

Normandy Drop In or Undermount Oval Hammered Copper
Lavatory Sink 21 5/8" x 14 9/16" x 6 7/8"



TECHNICAL DETAILS

ADA Compliance: When installed per ADA guidelines
Bowl Shape: Oval
Depth to Overflow: 102 mm
Drain Hole Depth: 41 mm
Drain Hole Diameter: 45 mm
Depth / Width: 370 mm
Height: 175 mm
Installation Type: Drop In or Undermount
Length: 549 mm
Number of Holes: Two Hole
Outer Rim Shape: Oval
Overflow Opening: Yes
Primary Material: Hammered Copper
Suggested Application: Bath

INSPIRATION

Like the antique French copper cookware that inspired them, our Normandy sinks lend a special warmth and richness to any environment. Each pure red copper design is hammered and polished by hand according to the old French tradition.

CODES & STANDARDS

Code # NOLV33:

PRODUCT FEATURES

Handcrafted in France from sheets of copper and formed in individual molds.
The Normandy sinks are finished with a burnishing hammer and polished by hand.
Suitable for master baths and powder rooms.

PRODUCT (NOTES)

Dimensions of sinks are nominal and are subject to slight variations.

WATERWORKS

NORMANDY

NOLV33

Normandy Drop In or Undermount Oval Hammered Copper Lavatory Sink 21 5/8" x 14 9/16" x 6 7/8"

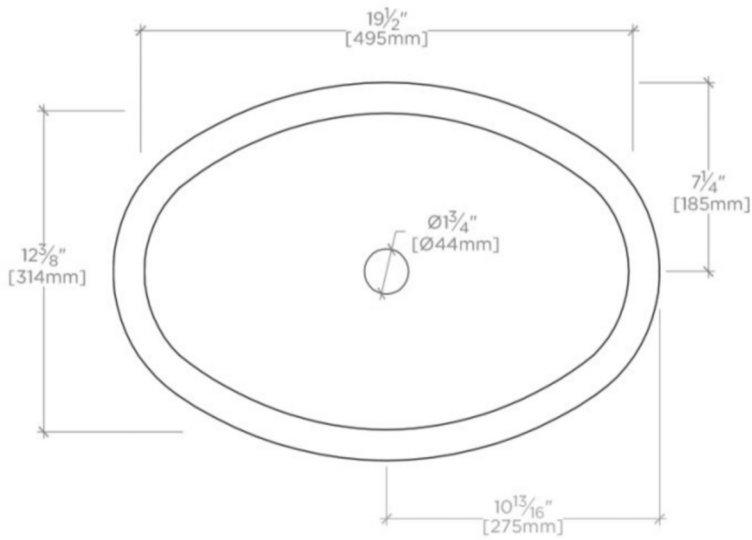

TOP VIEW

SCALE: 1/2"=1'-0"

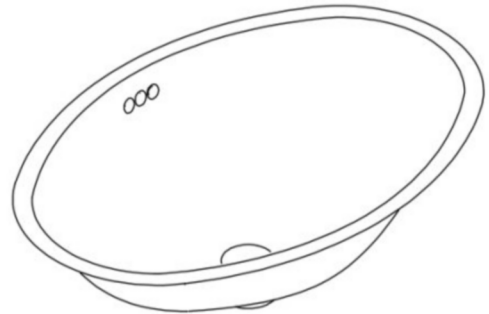

ISO VIEW

SCALE: 1/2"=1'-0"

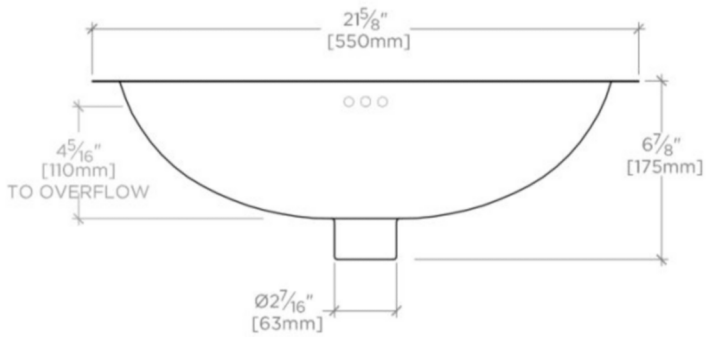

FRONT VIEW

SCALE: 1/2"=1'-0"

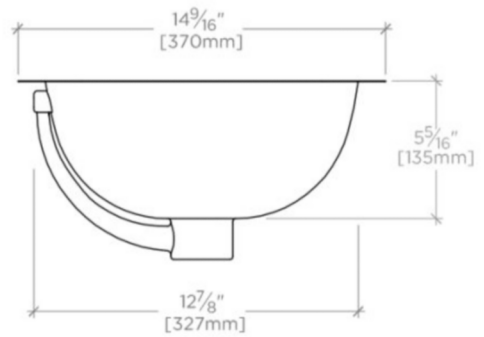

SIDE VIEW

SCALE: 1/2"=1'-0"