

INSTALLATION GUIDELINES

HANDSHOWER ON HOOK

HENRY OR HENRY CHRONOS HANDSHOWER ON HOOK

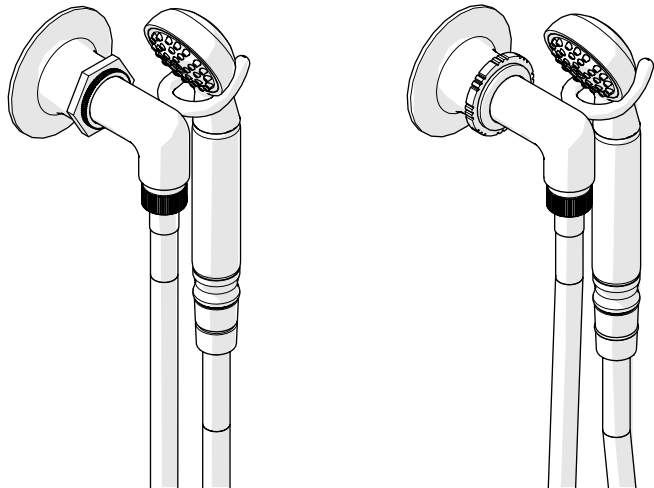

STYLES	
HNHS01	CNHS01

IMPORTANT:

- To ensure this product is installed properly, you must read and follow these guidelines.
- The owner/user of this product must keep this information for future reference.
- This product must be installed by a professional licensed contractor and must be on-site prior to rough-in. This allows the installer to visualize the installation.
- Be sure your installation conforms to all federal, state, and local codes. In the State of Massachusetts, all installations must comply with the rules and regulations set forth within 248 CMR.
- Inspect this product to ensure you have all the parts required for proper installation. Product is sold partially assembled but shown fully disassembled for illustrative and service purposes only.
- Use only a strap wrench or protected/smooth-jaw wrench on ANY finished surface.
- The use of certain plumber's putty may stain stone or tile surfaces.
- If further assistance is required, please contact Product Support at 1-800-927-2120 Monday through Friday, 8am - 6pm EST.
- Refer to the separate Service Parts Documents for available replacement parts.

TECHNICAL DETAILS:

DETAIL	SPECIFICATION
ADJUSTABLE VERSUS FIXED SPRAY	FIXED
DIAMETER OF HEAD	2-1/16" [50mm]
HANDSHOWER HOSE LENGTH	60" [1.5m]
INLET CONNECTION	1/2" FEMALE NPT †
INTEGRATED DIVERTER	NO
PIVOT	NO
WATER PRESSURE RANGE	85psi [6.0 bar] MAXIMUM 20psi [1.5 bar] MINIMUM
WATER PRESSURE RECOMMENDED	45psi [3.0 bar]

† **FOR INTERNATIONAL USE**, a 1/2" NPT Male x 1/2" BSPP Male ADAPTER (Style No. UNUK04) is provided. The BSPP end of the ADAPTER may be field cut.

ROUGH IN:

- Determine the ideal location for the HANDSHOWER and rough-in a well supported 1/2" NPT MALE NIPPLE † (not supplied) of appropriate length.

DIMENSION	VALUE
A	1-3/8" [35mm]
B	1/2" [13mm] - 7/8" [22mm] ‡

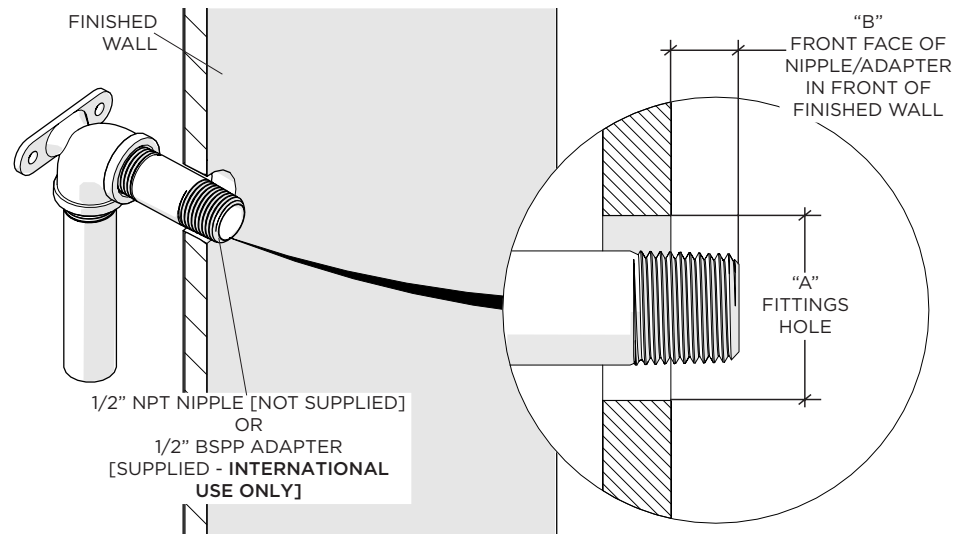

‡ The front face of the NIPPLE/ADAPTER must be within 1/2" [13mm] and 7/8" [22mm] in order for the sliding ESCUTCHEON to properly fit onto the ELBOW.

INSTALLATION GUIDELINES

HANDSHOWER ON HOOK

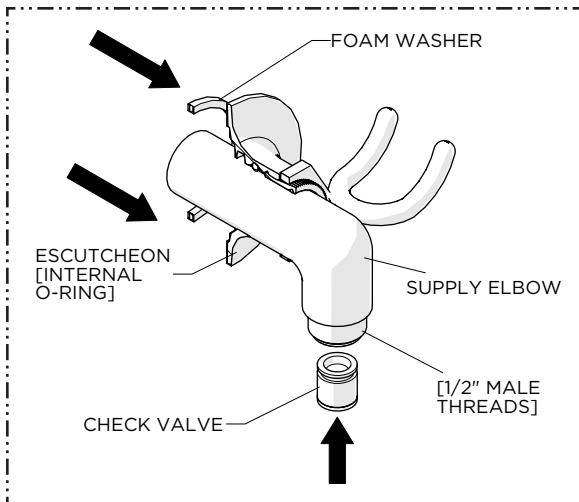

1. Slide the ESCUTCHEON and FOAM WASHER down the SUPPLY ELBOW.

NOTE: A CHECK VALVE is located in the outlet of the ELBOW.

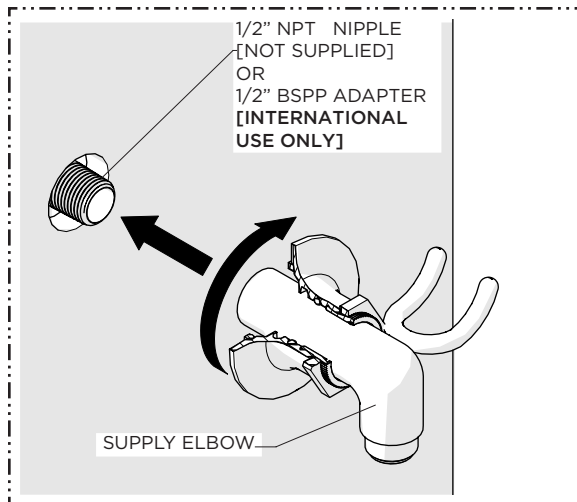

2. Thread and securely tighten the SUPPLY ELBOW onto the NIPPLE or BSPP ADAPTER.

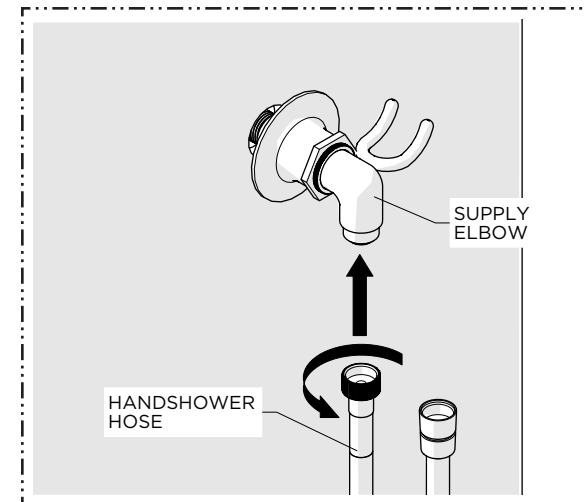

3. Thread and securely tighten the knurled end of the HOSE to the ELBOW.

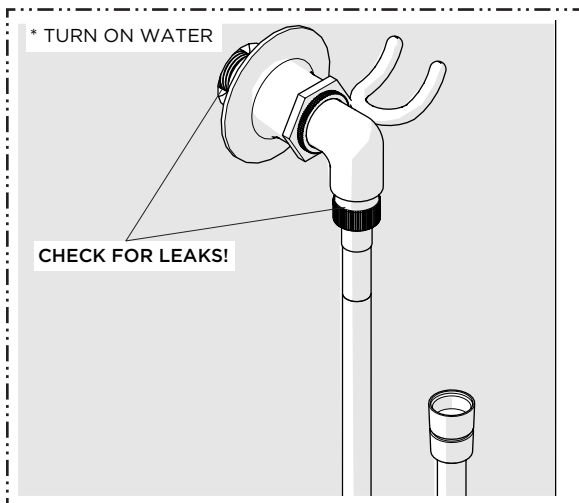

4. Turn on the water and a diverter/wall valve (sold separately) to flush out any debris in the supply line and inspect all connections for leaks then turn the water off.

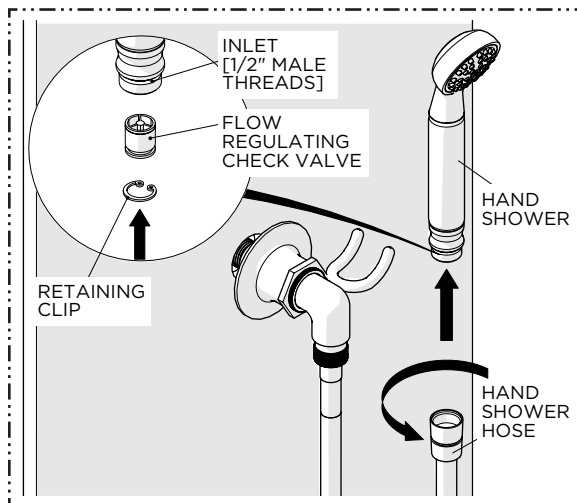

5. Thread and securely tighten the conical end of the HOSE to the HANDSHOWER then place it onto the HOOK.

NOTE: A FLOW REGULATING CHECK VALVE is located in the inlet of the HANDSHOWER.

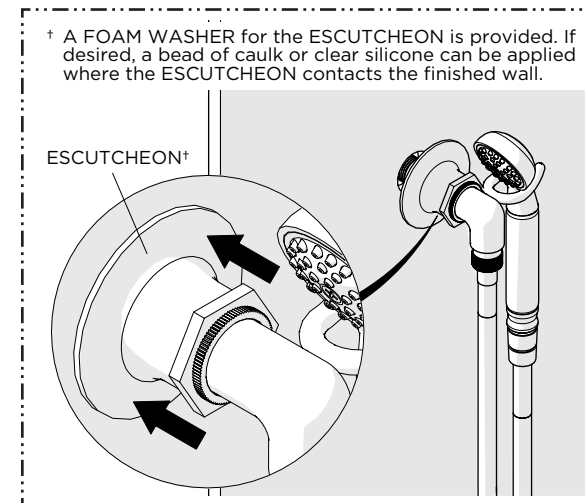

6. Slide the ESCUTCHEON up the ELBOW until it contacts the finished wall.

* A FOAM WASHER for the ESCUTCHEON is provided. If desired, a bead of caulk or clear silicone can be applied where the ESCUTCHEON contacts the finished wall.