

BERKLEY

BKBT78

Berkley 66" x 38" x 22" Rectangular Bathtub with End Drain and LINEAR Integrated Waste and Overflow



SHOWN IN BERKLEY 66" X 38" X 22" RECTANGULAR BATHTUB WITH END DRAIN AND LINEAR INTEGRATED WASTE AND OVERFLOW | BKBT78

TECHNICAL DETAILS

ADA Compliance: No
 Adjustable Levelers Feet: Y
 Assembly Configuration: One Piece
 Bathing Type: Bathing, Soaking and Showering
 Bathing Well Sitting Angle: 110 degree_angle
 Depth To Overflow: 17 3/8"
 Depth/Width: 31"
 Drain Hole Depth: 5/8"
 Drain Hole Diameter: 2"
 Drilling Option: None
 Height: 20"
 Installation Type: Drop In or Undermount
 Item Weight Filled: 930.0 pounds
 Length: 60"
 Number Of Holes: Two Hole
 Overflow Opening: Yes
 Primary Material: Acrylic
 Single Or Double Ended: Single Ended
 Suggested Application: Bath

INSPIRATION

Our Berkley and Smyth collections encompass core elements for every bath. These collections are perfect for all design aesthetics.

CODES & STANDARDS

cUL Model Number: 6638; CSA B45.5/IAPMO Z124

PRODUCT FEATURES

Our Berkley and Smyth tubs are made in the USA of acrylic material.

Rectangular Drop in or Undermount tubs with tight interior corners

The Berkley and Smyth are available with an integrated slot overflow and standard/no integrated overflow.

Marble surround (Bardiglio shown) and ceramic tile (Cottage in Blanca shown) are sold separately from the bathtub.

Our Smyth/Berkley Tubs that are 18" Deep meet the ADA depth requirements.

CERTIFICATIONS



PRODUCT (NOTES)

Dimensions of fixtures are nominal. Measure your actual product for rough-in details.

WATERWORKS

BERKLEY

BKBT78

Berkley 66" x 38" x 22" Rectangular Bathtub with End Drain and LINEAR Integrated Waste and Overflow

*ALL DIMENSIONS ARE +/- 1/2" [13mm]

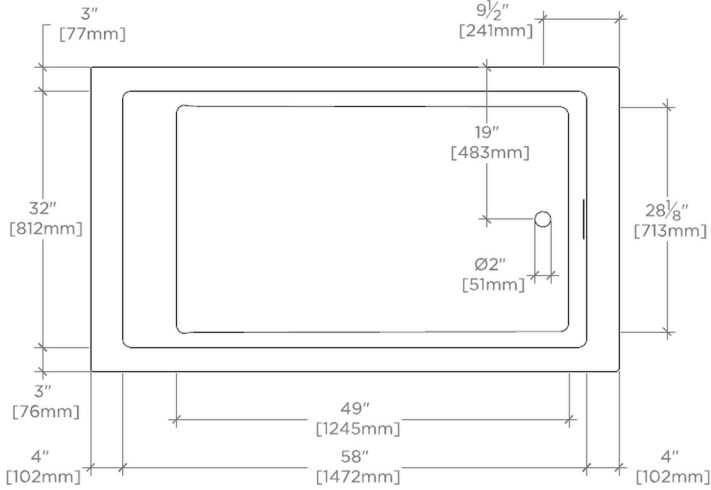

TOP VIEW

SCALE: 1/2"=1'-0"

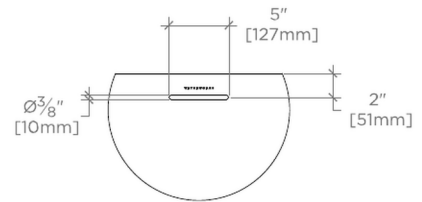

OVERFLOW DETAIL

DO NOT SCALE

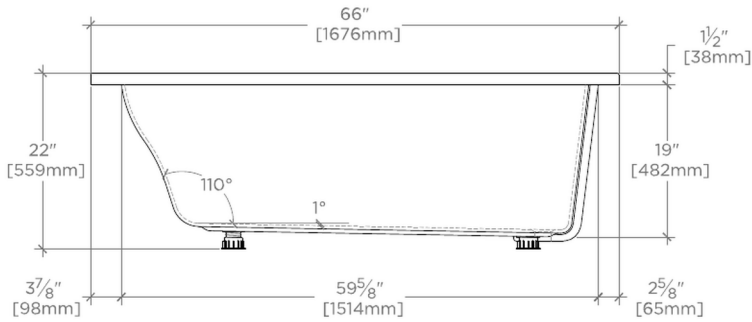

SIDE VIEW

SCALE: 1/2"=1'-0"

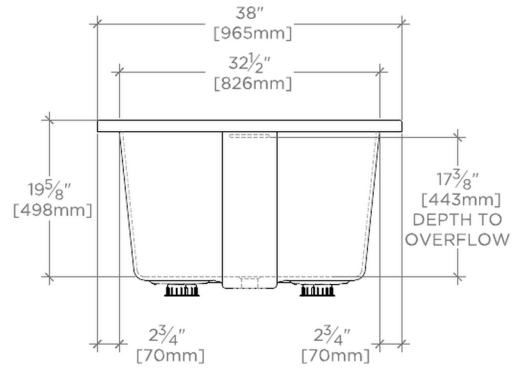

END VIEW

SCALE: 1/2"=1'-0"