

HENRY

HKM401

Henry One Hole Bar Faucet with Cross Handle

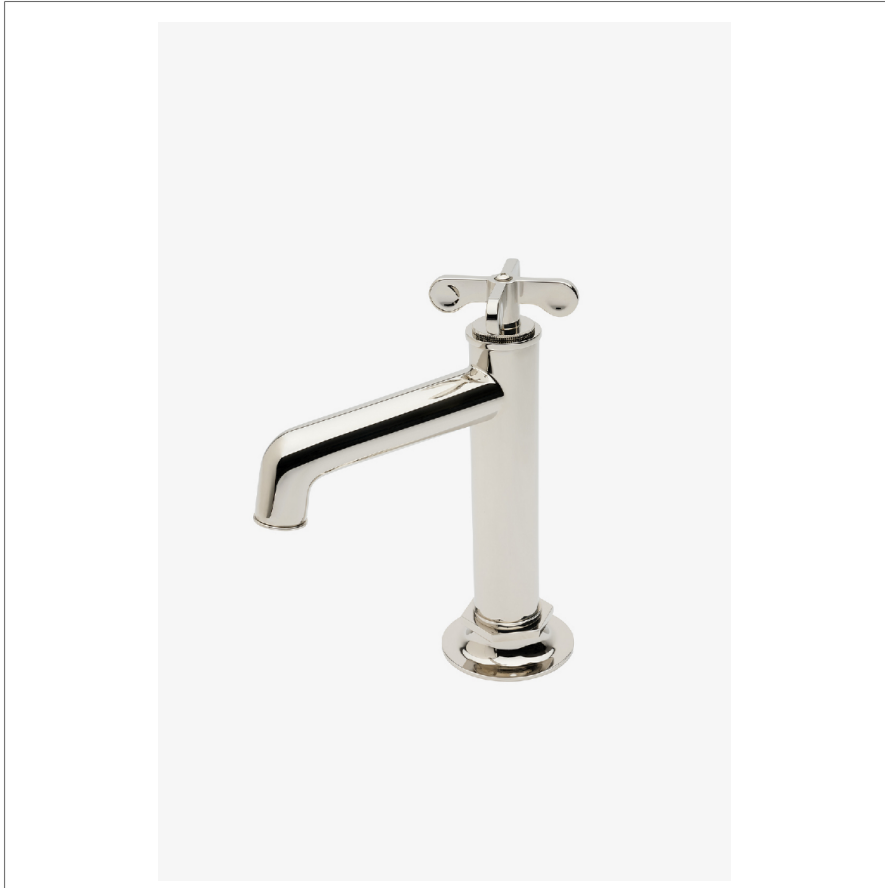

SHOWN IN HENRY ONE HOLE BAR FAUCET WITH CROSS HANDLE | HKM401

TECHNICAL DETAILS

ADA Compliance: Yes
Deck Thickness Maximum: 2 5/8"
Deck Thickness Minimum: 1/4"
Fittings Hole Diameter: 1 3/8"
Handle Turn Angle: Quarter Turn
Inlet Connection Size: 3/8"
Inlet Connection Type: Compression Connection Hoses
Number Of Holes: One Hole
Primary Material: Brass
Restricted Maximum Flow Rate: 1.2 gpm
Spout Swivel: N
Valve Material: Brass and Ceramic
Water Pressure Maximum: 85.0 psi
Water Pressure Minimum: 20.0 psi
Water Pressure Recommended: 45.0 psi

INSPIRATION

Influenced by the connection of industry and art Henry easily transitions between modern, traditional, utilitarian and classic settings.

CODES & STANDARDS

HKM401X, NSF/ANSI/CAN 61:Q < 1, NSF/ANSI/CAN 372, ASME A112.18.1/CSA B125.1, CEC, DOE, State of MA

PRODUCT FEATURES

Cross Handle

Stocked in Chrome, Nickel, Brass and Dark Nickel

Available in 1.2gpm (4.5L/min)

CERTIFICATIONS



PRODUCT (NOTES)

WATERWORKS

HENRY

HKM401

Henry One Hole Bar Faucet with Cross Handle

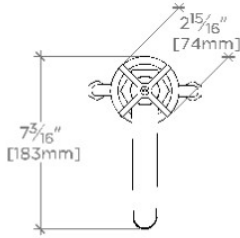

TOP VIEW

SCALE: 1/2"=1'-0"

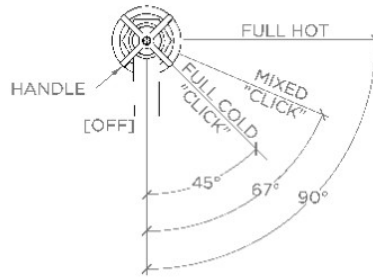

HANDLE OPERATION

SCALE: 1/2"=1'-0"

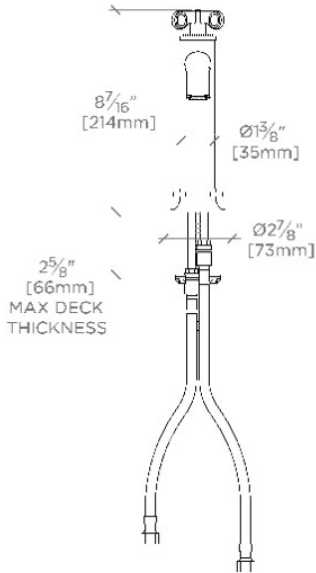

FRONT VIEW

SCALE: 1/2"=1'-0"

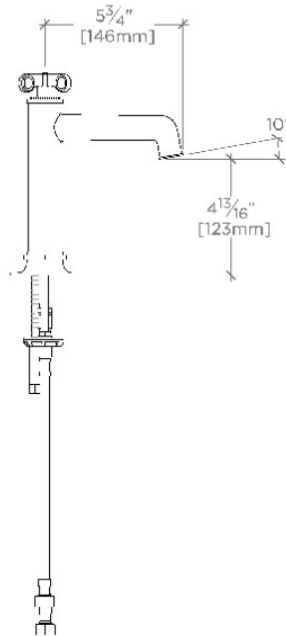

SIDE VIEW

SCALE: 1/2"=1'-0"

NOTE:
ADAPTER AND GASKET
(X2) INCLUDED -
INTERNATIONAL USE
ONLY

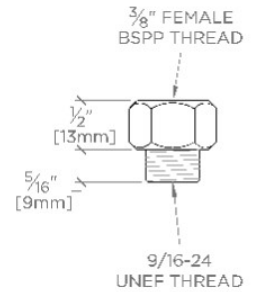
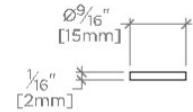

NOT TO SCALE