

Universal

UNS335

Universal 2 3/4" Showerhead with Adjustable Spray with 8" Wall Mounted 45 Degree Shower Arm and Transitional Flange



SHOWN IN UNIVERSAL 2 3/4" SHOWERHEAD WITH ADJUSTABLE SPRAY WITH 8" WALL MOUNTED 45 DEGREE SHOWER ARM AND TRANSITIONAL FLANGE | UNS335

TECHNICAL DETAILS

Adjustable Versus Fixed Spray: Adjustable Spray
 Fittings Hole Diameter: 32 mm
 Flow Restriction Options: 1.5, 1.75, 2.0
 Inlet Connection Size: 1/2"
 Inlet Connection Type: Male NPT
 Pivot: Y
 Primary Material: Brass
 Restricted Maximum Flow Rate: 6.6 liters/min
 Water Pressure Maximum: 6.0 bar
 Water Pressure Minimum: 1.5 bar
 Water Pressure Recommended: 3.0 bar

INSPIRATION

Our Universal collection features timeless designs complementing any of our Waterworks. With a wide range of product, from fittings to accessories, Universal adds exquisite proportion and balance to any environment.

CODES & STANDARDS

UNS335X, ASME A112.18.1/CSA B125.1, CEC(1.5GPM & 1.75GPM Only), WaterSense(1.5GPM, 1.75GPM & 2.0GPM Only), DOE, State of MA

PRODUCT FEATURES

- Made of Brass
- Features a swivel 2 3/4" showerhead with two adjustable spray patterns
- Includes a 8" wall mounted 45 degree shower arm
- Stocked in Brass, Chrome and Nickel
- Showerhead available in 1.75gpm (6.6L/min) flow rate

CERTIFICATIONS



PRODUCT (NOTES)

WATERWORKS

Universal

UNS335

Universal 2 3/4" Showerhead with Adjustable Spray with 8" Wall Mounted 45 Degree Shower Arm and Transitional Flange

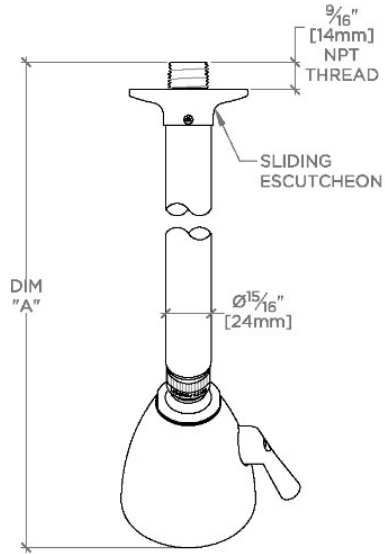

TOP VIEW SCALE: 3"=1'-0"

STYLE NO.	DIM "A"	DIM "B"
UNS334	10 1/16" [256mm]	6 1/4" [158mm]
UNS335	12 1/6" [307mm]	8 1/4" [209mm]

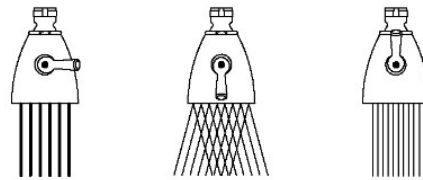

SPRAY PATTERNS

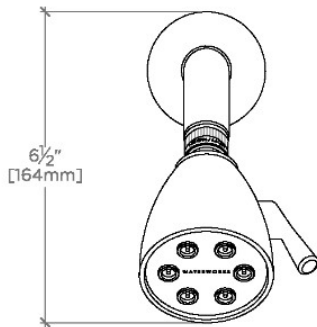

FRONT VIEW SCALE: 3"=1'-0"

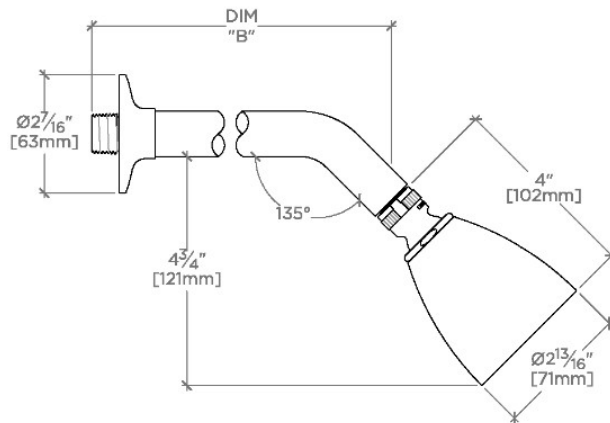

SIDE VIEW SCALE: 3"=1'-0"