

FORO

FRS145

Foro 4" Showerhead with 8" Wall Mounted 45 Degree Shower Arm

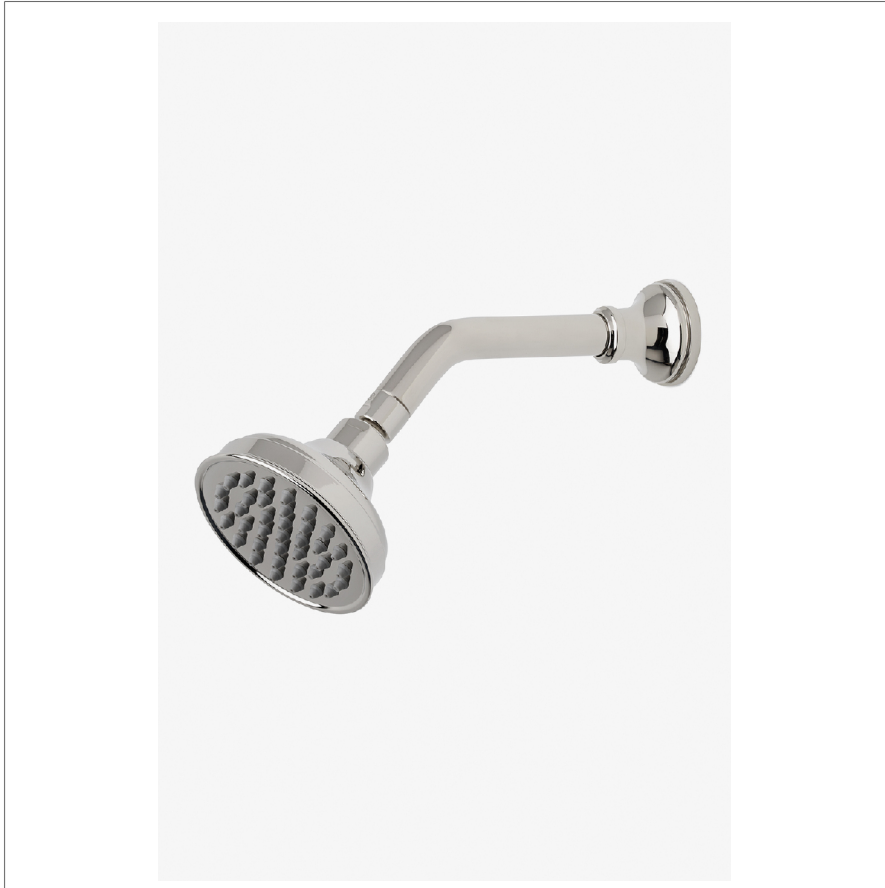

SHOWN IN FORO 4" SHOWERHEAD WITH 8" WALL MOUNTED 45 DEGREE SHOWER ARM | FRS145

TECHNICAL DETAILS

Adjustable Versus Fixed Spray: Fixed
Fittings Hole Diameter: 1 1/4"
Inlet Connection Size: 1/2"
Inlet Connection Type: Male NPT
Pivot: Y
Primary Material: Brass
Restricted Maximum Flow Rate: 1.75 gpm
Water Pressure Maximum: 85.0 psi
Water Pressure Minimum: 20.0 psi
Water Pressure Recommended: 45.0 psi

INSPIRATION

A mix of historical references, including finely etched vintage silver, come together in this twist on classical design - a wonderfully elegant formal statement.

CODES & STANDARDS

FRS145X, ASME A112.18.1/CSA B125.1, CEC(1.5GPM & 1.75GPM Only), DOE, State of MA

PRODUCT FEATURES

Made of Brass

Features a swivel 4" showerhead with easy clean rubber nozzles

Includes a 8" wall mounted 45 degree shower arm

Stocked in Brass, Chrome, Nickel and Matte Nickel

Showerhead available in 1.75gpm (6.6L/min) flow rate

CERTIFICATIONS



PRODUCT (NOTES)

WATERWORKS

FORO

FRS145

Foro 4" Showerhead with 8" Wall Mounted 45 Degree Shower Arm

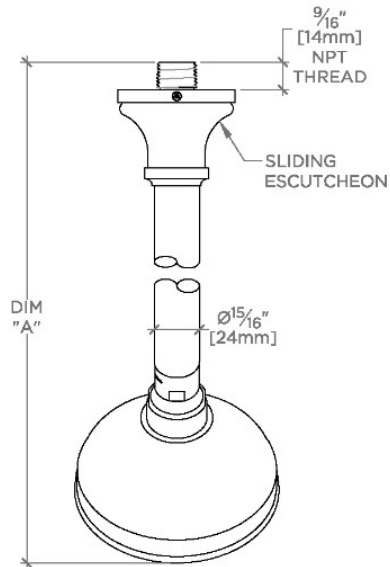

TOP VIEW SCALE: 3"=1'-0"

STYLE NO.	DIM "A"	DIM "B"
ETS144	10 ⁷ / ₁₆ " [265mm]	6 ³ / ₄ " [158mm]
FRS144		
JUS144		
ETS145	12 ⁷ / ₁₆ " [315mm]	8 ³ / ₄ " [209mm]
FRS145		
JUS145		

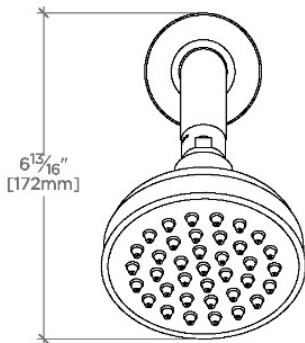

FRONT VIEW SCALE: 3"=1'-0"

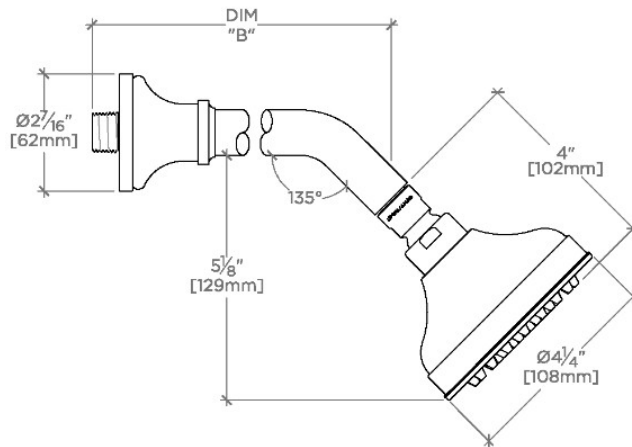

SIDE VIEW SCALE: 3"=1'-0"