

Henry

HNCH06

Henry 6" Ceiling Mounted Shower Arm with Flange

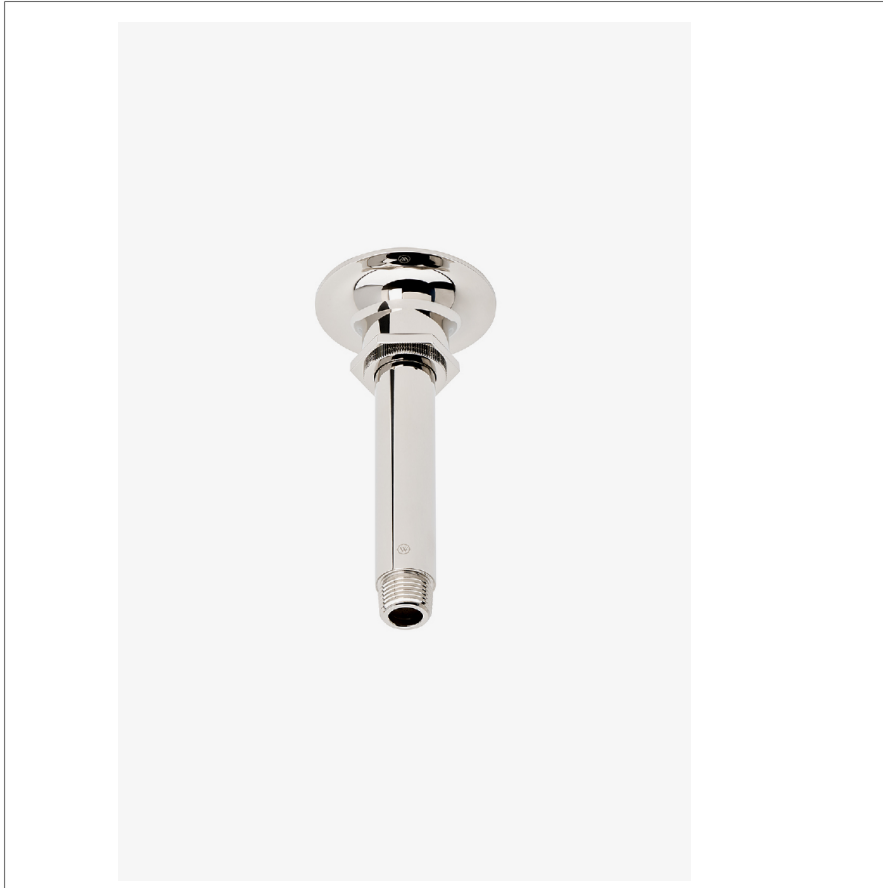

SHOWN IN HENRY 6" CEILING MOUNTED SHOWER ARM WITH FLANGE | HNCH06

TECHNICAL DETAILS

Fittings Hole Diameter: 32 mm
Inlet Connection Size: 1/2"
Inlet Connection Type: Male NPT
Outlet Connection Size: 1/2"
Outlet Connection Type: Male NPT
Water Pressure Recommended: 3.0 bar

INSPIRATION

Celebrating the connection of industry and art, Henry transitions effortlessly between modern, traditional, and classic settings. These iconic fittings blend 19th-century industrial and artistic references for a look that's forever of the moment—familiar yet wholly original.

CODES & STANDARDS

PRODUCT FEATURES

Compatible with an assortment of Waterworks showerheads, sold separately

Brass Construction

Includes 6" ceiling mounted shower arm

Stocked in Chrome, Nickel and Brass

CERTIFICATIONS

PRODUCT (NOTES)

Henry

HNCH06

Henry 6" Ceiling Mounted Shower Arm with Flange

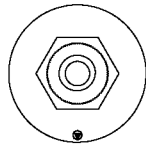

CEILING VIEW SCALE: 3"=1'-0"

STYLE NO.	DIM "A"	DIM "B"
HNCH06	7 ¹ / ₈ " [181mm]	6 ⁹ / ₁₆ " [167mm]
HNCH12	13 ¹ / ₈ " [334mm]	12 ⁹ / ₁₆ " [319mm]
HNCH18	19 ¹ / ₈ " [486mm]	18 ⁹ / ₁₆ " [471mm]
HNCH24	25 ¹ / ₈ " [639mm]	24 ⁹ / ₁₆ " [624mm]

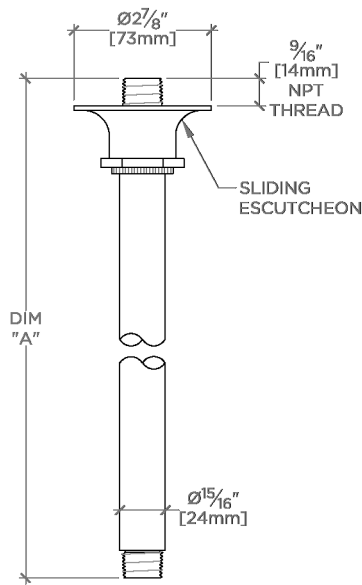

FRONT VIEW SCALE: 3"=1'-0"

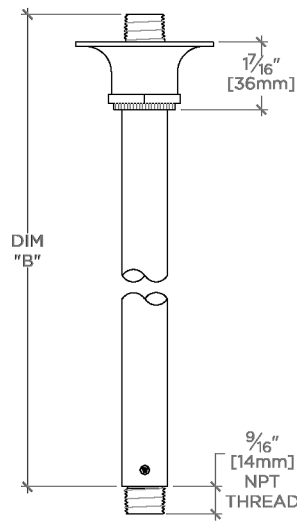

SIDE VIEW SCALE: 3"=1'-0"