

DASH

DSS344

Dash 3 1/2" Showerhead with Adjustable Spray with 6" Wall Mounted 45 Degree Shower Arm



SHOWN IN DASH 3 1/2" SHOWERHEAD WITH ADJUSTABLE SPRAY WITH 6" WALL MOUNTED 45 DEGREE SHOWER ARM | DSS344

TECHNICAL DETAILS

Adjustable Versus Fixed Spray: Adjustable Spray
 Fittings Hole Diameter: 1 1/4"
 Flow Restriction Options: 1.5, 1.75, 2.0
 Inlet Connection Size: 1/2"
 Inlet Connection Type: Male NPT
 Pivot: Y
 Primary Material: Brass
 Restricted Maximum Flow Rate: 1.75 gpm
 Water Pressure Maximum: 85.0 psi
 Water Pressure Minimum: 20.0 psi
 Water Pressure Recommended: 45.0 psi

INSPIRATION

A blend of art and function, Dash pays homage to design elements of the 1930s with pared-down shapes, softened curves and minimal details.

CODES & STANDARDS

DSS344X, ASME A112.18.1/CSA B125.1, CEC(1.5GPM & 1.75GPM Only), WaterSense(1.5GPM, 1.75GPM & 2.0GPM Only), DOE, State of MA

PRODUCT FEATURES

- Made of Brass
- Features a swivel 3 1/2" showerhead with two adjustable spray patterns
- Includes a 6" wall mounted 45 degree shower arm
- Stocked in Brass, Chrome, Nickel and Matte Nickel
- Showerhead available in 1.75gpm (6.6L/min) flow rate

CERTIFICATIONS



PRODUCT (NOTES)

WATERWORKS

DASH

DSS344

Dash 3 1/2" Showerhead with Adjustable Spray with 6" Wall Mounted 45 Degree Shower Arm

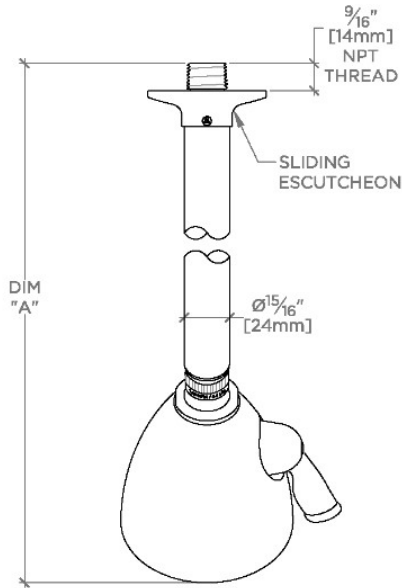

TOP VIEW

SCALE: 3"=1'-0"

STYLE NO.	DIM "A"	DIM "B"
DSS344	10 ⁷ / ₈ " [276mm]	6 ¹ / ₄ " [158mm]
HGS344		
RRS344		
DSS345	12 ⁷ / ₈ " [326mm]	8 ¹ / ₄ " [209mm]
HGS345		
RRS345		

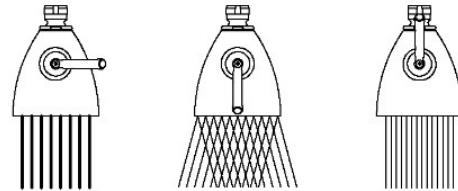

SPRAY PATTERNS

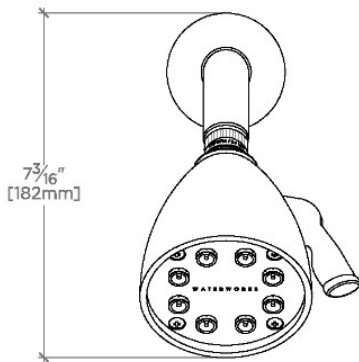

FRONT VIEW

SCALE: 3"=1'-0"

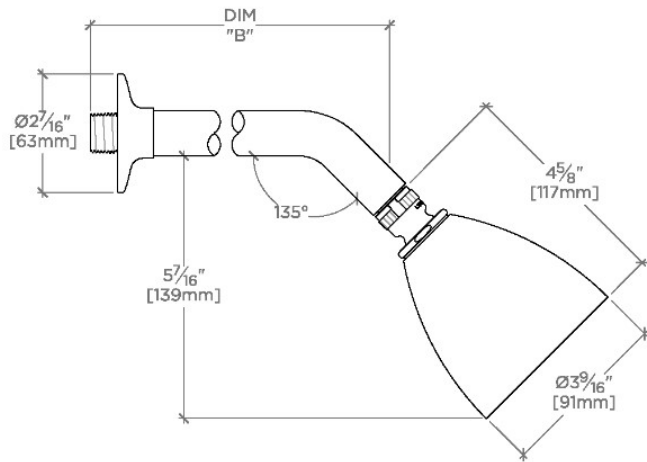

SIDE VIEW

SCALE: 3"=1'-0"