

.25

PTS220

.25 12" Rain Showerhead with 6" Ceiling Mounted Shower Arm



SHOWN IN .25 12" RAIN SHOWERHEAD WITH 6" CEILING MOUNTED SHOWER ARM | PTS220

TECHNICAL DETAILS

Adjustable Versus Fixed Spray: Fixed
 Fittings Hole Diameter: 1 1/4"
 Flow Restriction Options: 1.5, 1.75, 2.0
 Inlet Connection Size: 1/2"
 Inlet Connection Type: Male NPT
 Pivot: Y
 Primary Material: Brass
 Restricted Maximum Flow Rate: 1.75 gpm
 Water Pressure Maximum: 85.0 psi
 Water Pressure Minimum: 20.0 psi
 Water Pressure Recommended: 45.0 psi

INSPIRATION

.25 is the ultimate in utilitarian elegance: A simple and understated design that is equally functional and beautiful.

CODES & STANDARDS

PTS220X, ASME A112.18.1/CSA B125.1, CEC(1.5GPM & 1.75GPM Only), WaterSense(1.5GPM, 1.75GPM & 2.0GPM Only), DOE, State of MA

PRODUCT FEATURES

- Made of Brass
- Features a swivel 12" rain showerhead with easy clean rubber nozzles
- Includes a 6" ceiling mounted shower arm
- Stocked in Brass, Chrome, Nickel and Matte Nickel
- Rain showerhead available in 1.75gpm (6.6L/min) flow rate

CERTIFICATIONS



PRODUCT (NOTES)

.25 12" Rain Showerhead with 6" Ceiling Mounted Shower Arm

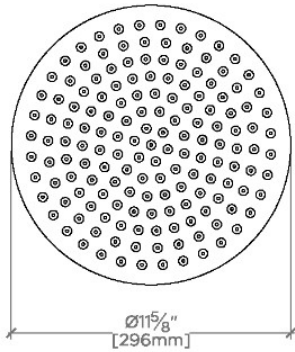

CEILING VIEW SCALE: 1/2"=1'-0"

STYLE NO.	DIM "A"	DIM "B"
LVS220	10 ⁵ / ₁₆ " [262mm]	6 ⁹ / ₁₆ " [167mm]
PTS220		
LVS221	16 ⁵ / ₁₆ " [414mm]	12 ⁹ / ₁₆ " [319mm]
PTS221		
LVS222	22 ⁵ / ₁₆ " [566mm]	18 ⁹ / ₁₆ " [472mm]
PTS222		

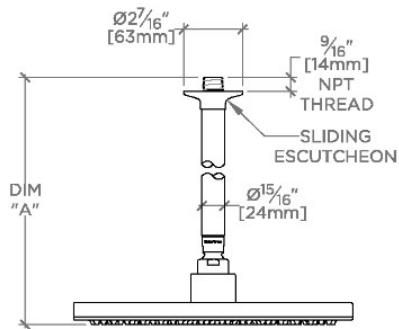

FRONT VIEW SCALE: 1/2"=1'-0"

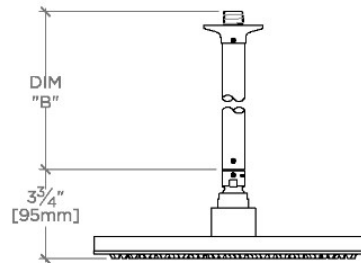

SIDE VIEW SCALE: 1/2"=1'-0"